

# Appendix C – Unattended noise monitoring charts

## 160 Rose Hill Rd

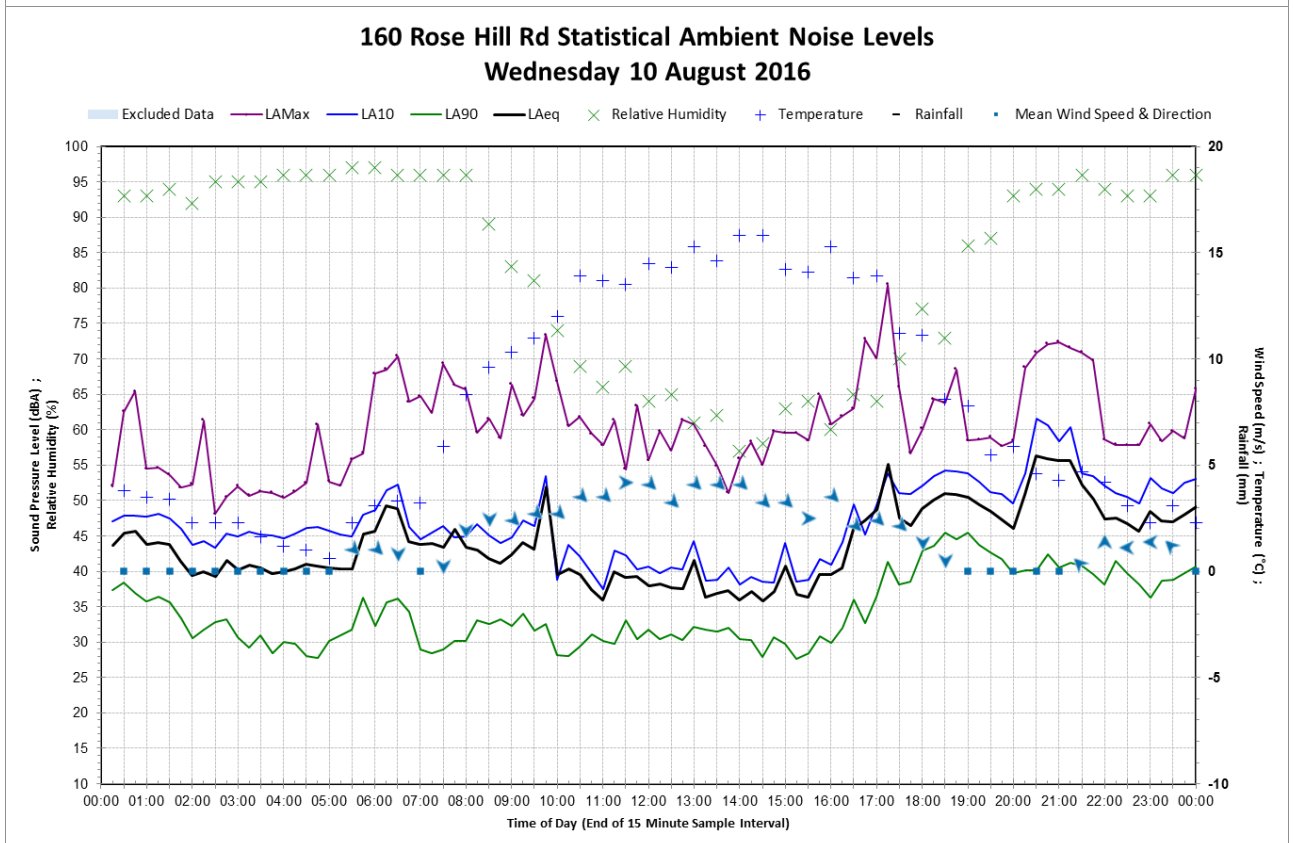

### 160 Rose Hill Rd Statistical Ambient Noise Levels Tuesday 9 August 2016

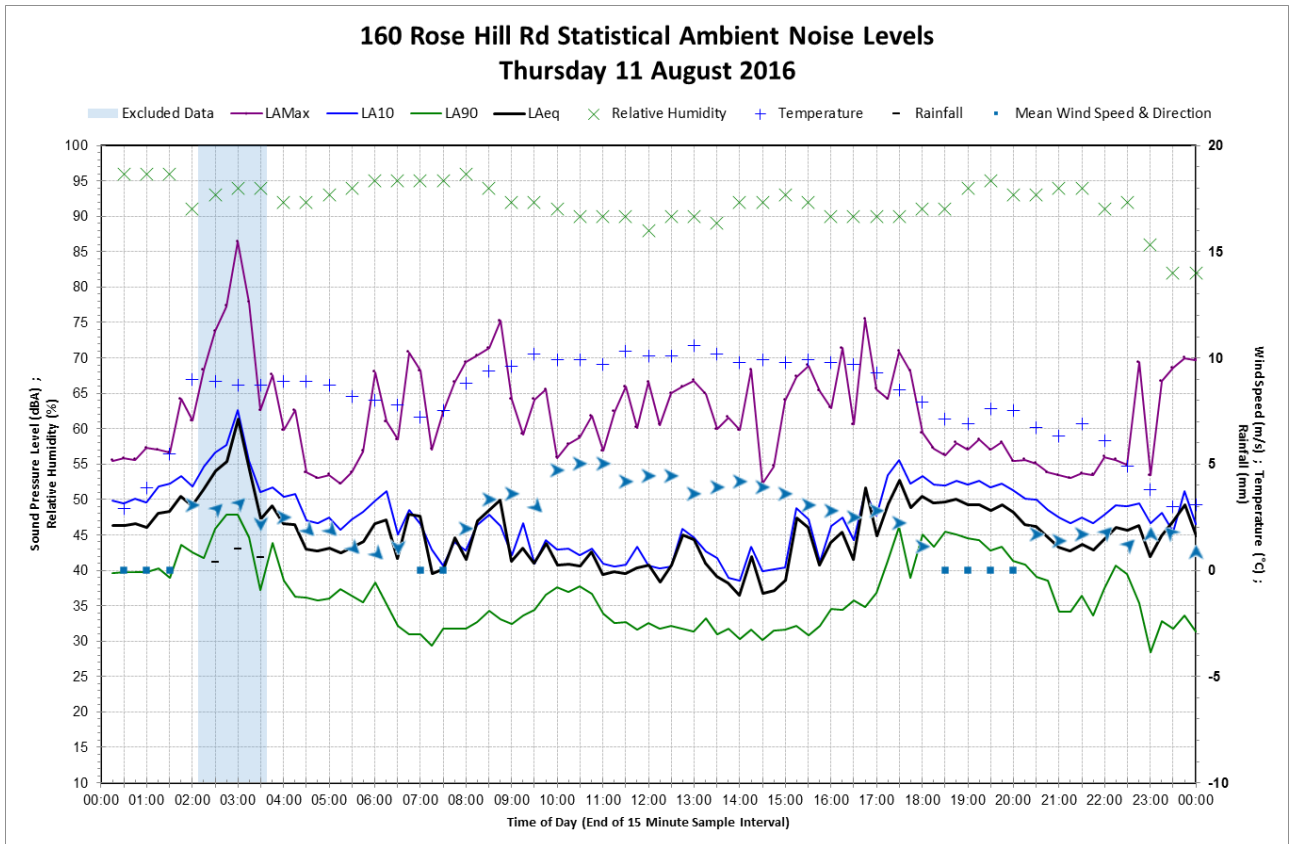
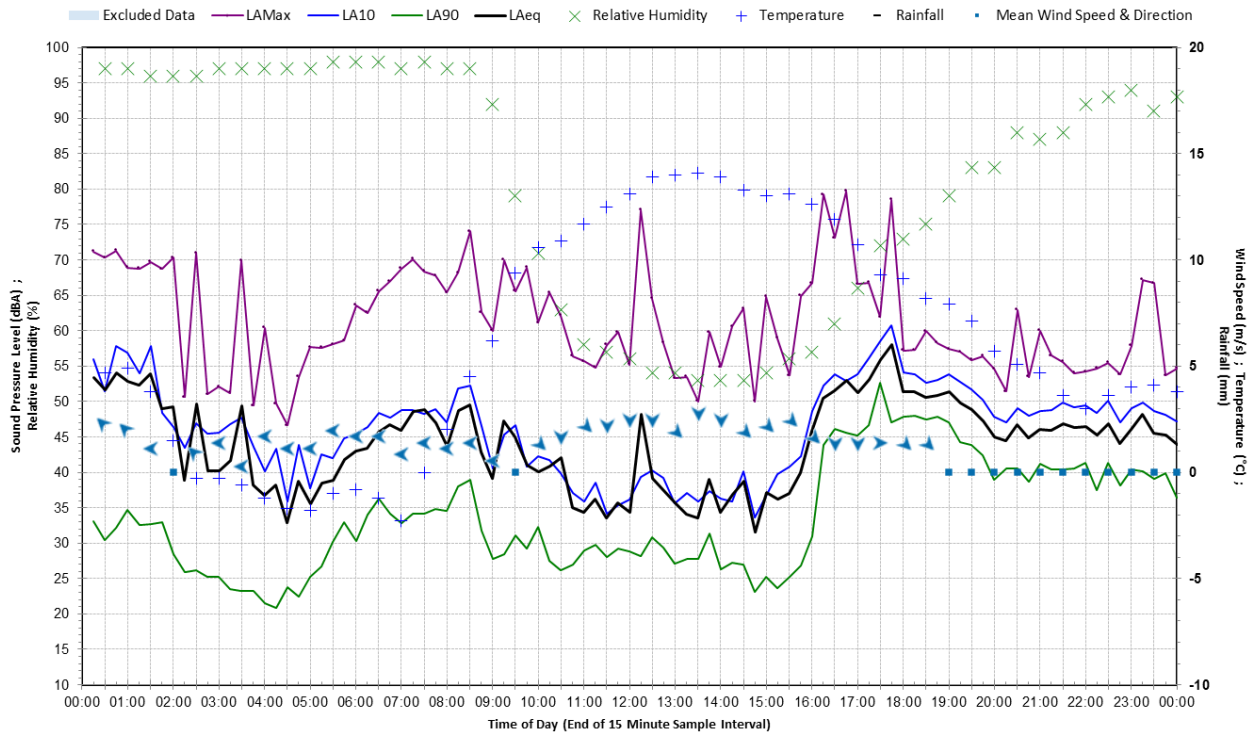

### 160 Rose Hill Rd Statistical Ambient Noise Levels Monday 8 August 2016

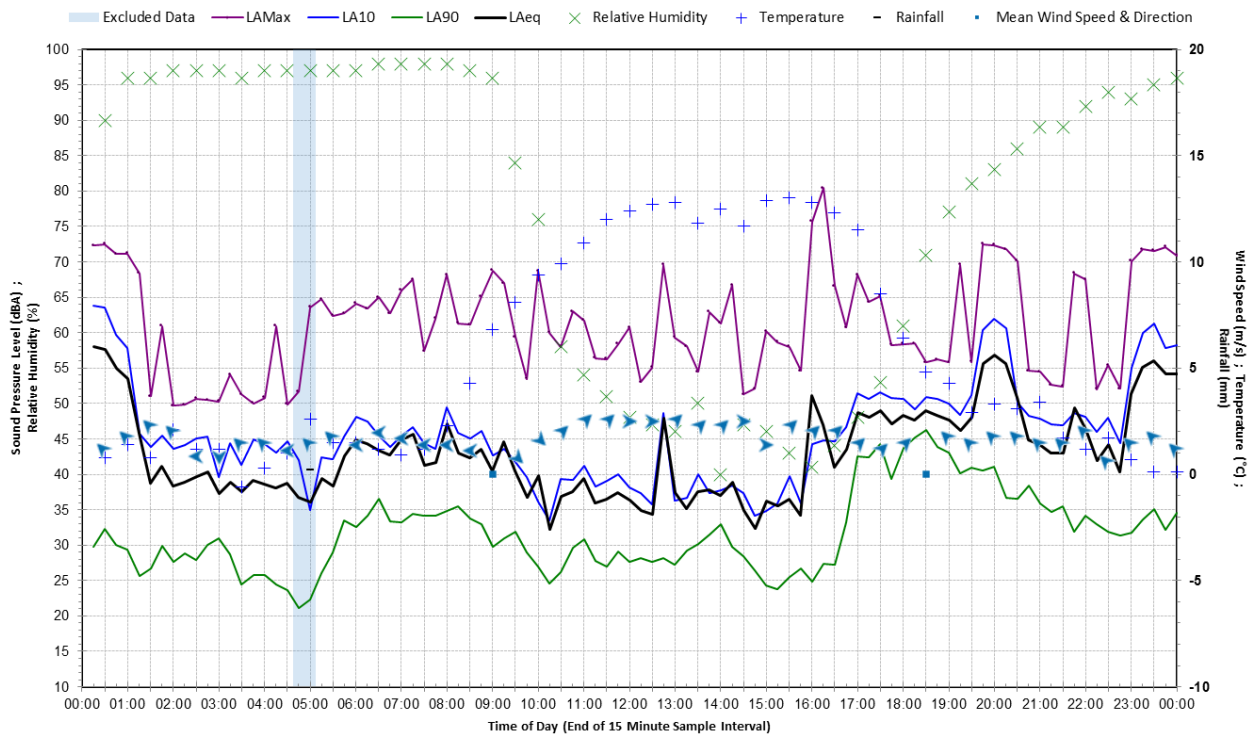

### 160 Rose Hill Rd Statistical Ambient Noise Levels Sunday 7 August 2016

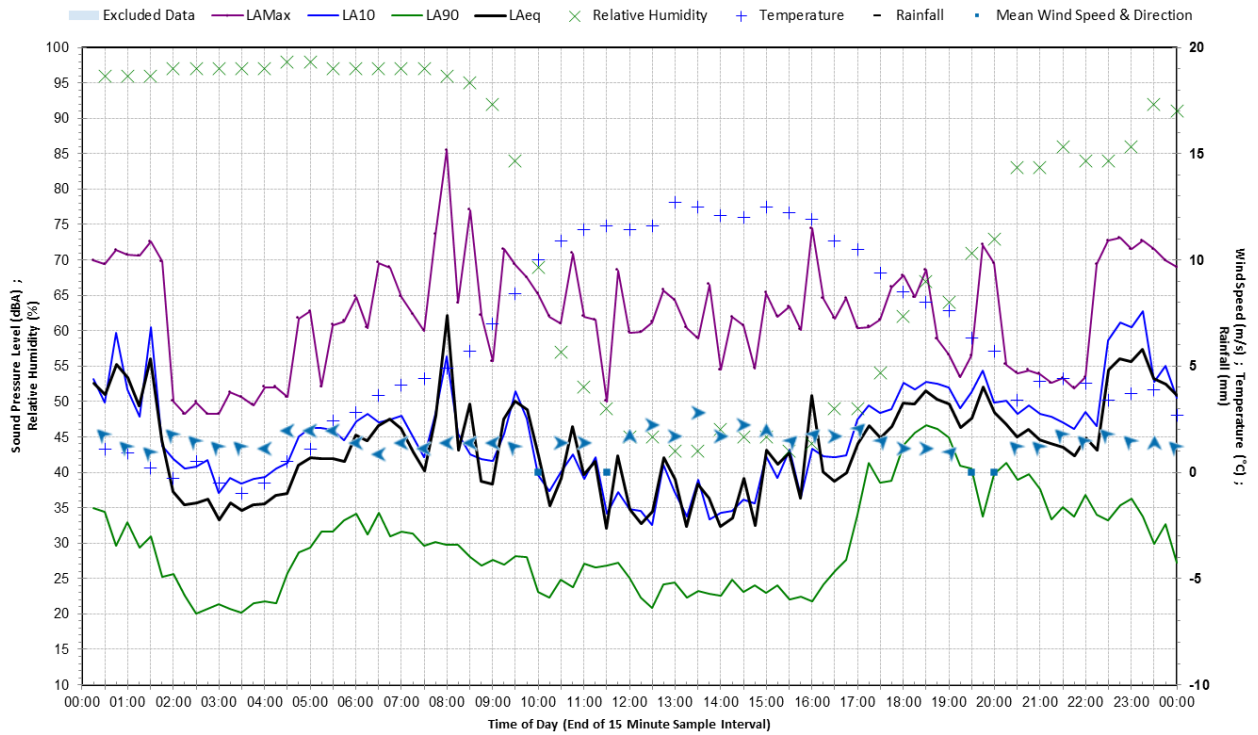

### 160 Rose Hill Rd Statistical Ambient Noise Levels Saturday 6 August 2016

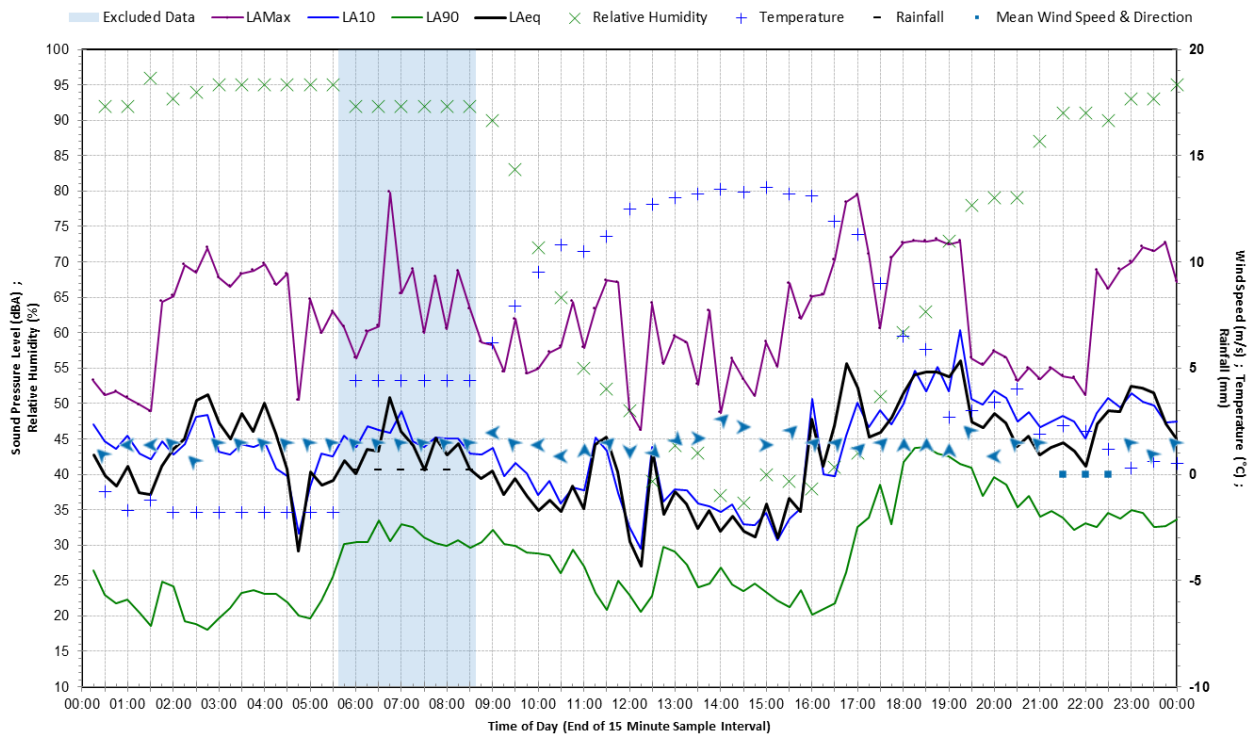

### 160 Rose Hill Rd Statistical Ambient Noise Levels Friday 5 August 2016

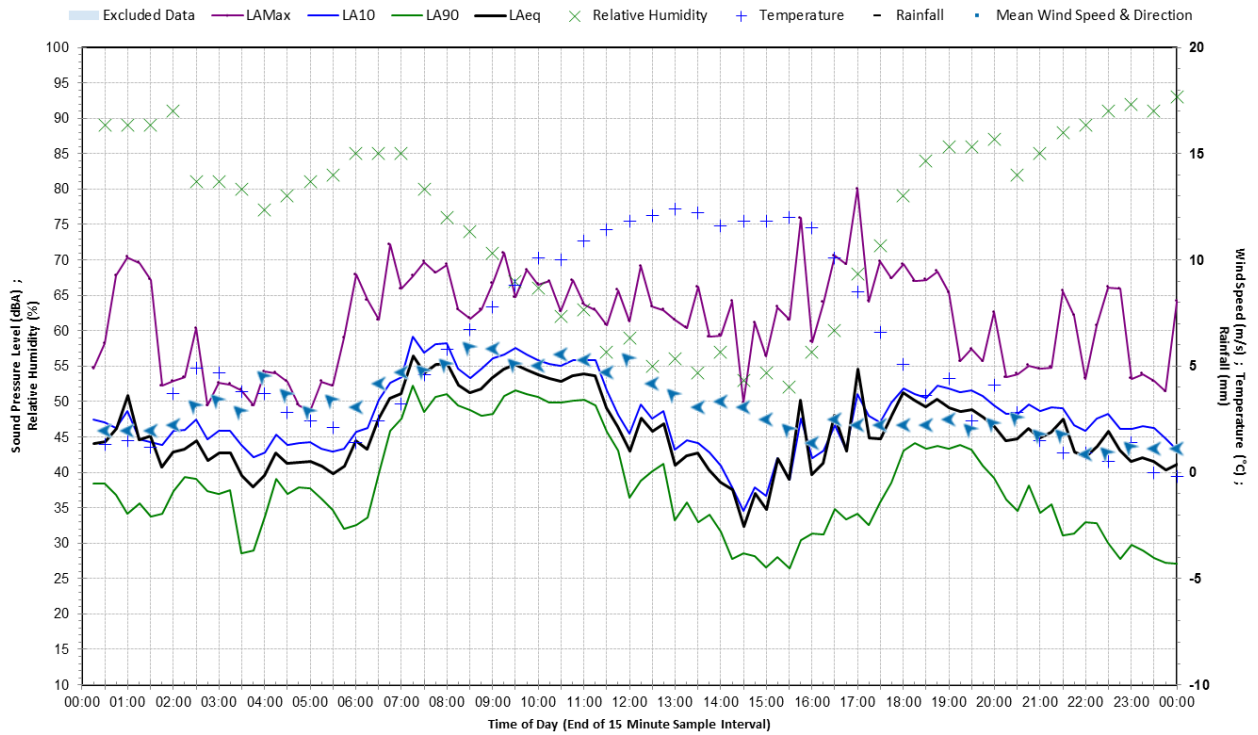

### 160 Rose Hill Rd Statistical Ambient Noise Levels Thursday 4 August 2016

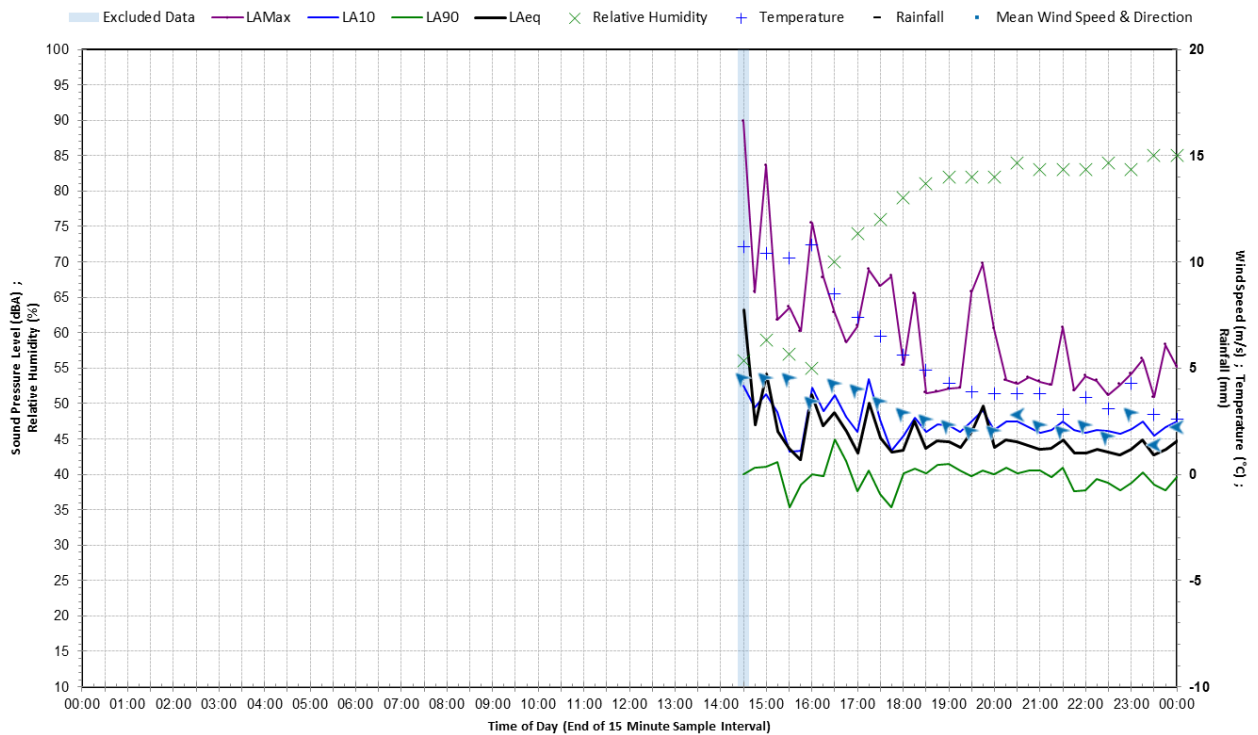

### 160 Rose Hill Rd Statistical Ambient Noise Levels Friday 12 August 2016

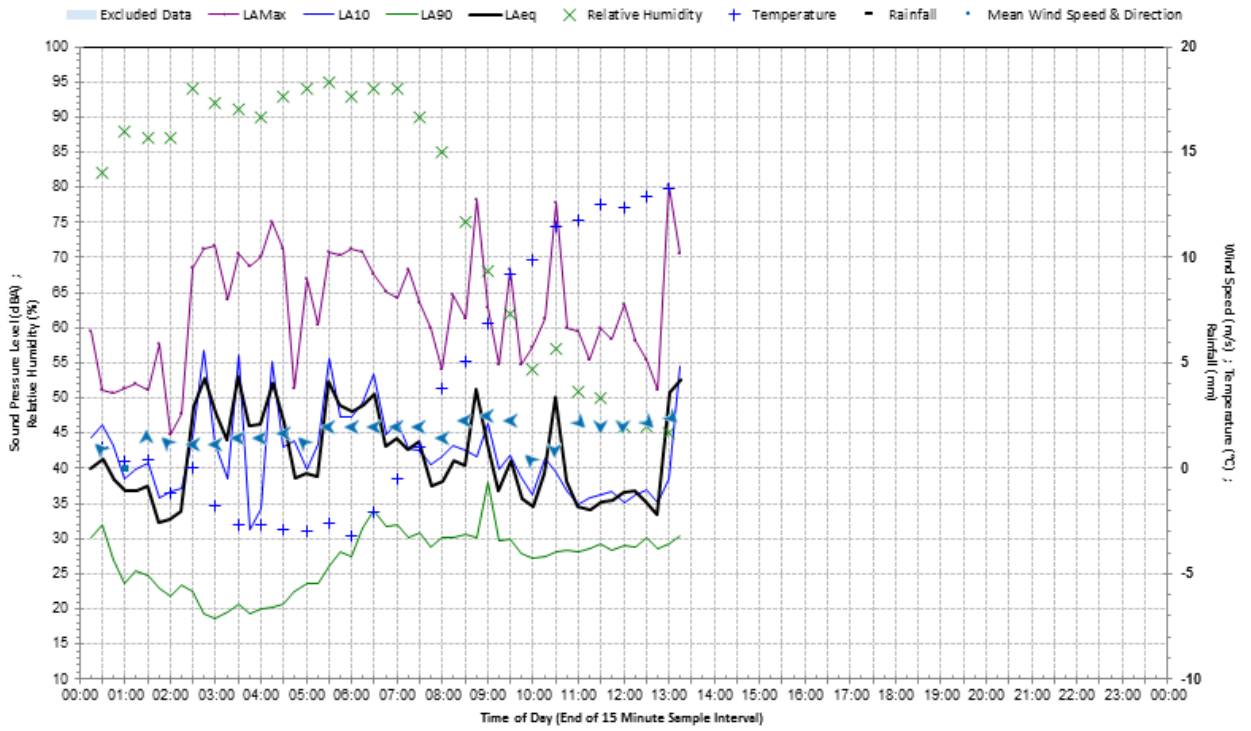

GHD

Level 3 GHD Tower 24 Honeysuckle Drive Newcastle NSW 2300  
PO Box 5403 Hunter Region Mail Centre NSW 2310  
T: (02) 4979 9999 F: (02) 4979 9988 E: ntlmail@ghd.com

© GHD 2016

This document is and shall remain the property of GHD. The document may only be used for the purpose for which it was commissioned and in accordance with the Terms of Engagement for the commission. Unauthorised use of this document in any form whatsoever is prohibited.

g:\22\18380\WP\113802.docx

Document Status

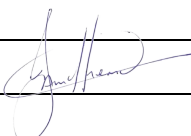
Rev No.	Author	Reviewer		Approved for Issue		
		Name	Signature	Name	Signature	Date
0	A Rees	C Evenden		M Dunlop		10/10/2016
1	A Rees	C. Evenden	<i>C Evenden</i>	J. McPherson		23/12/2016

[www.ghd.com](http://www.ghd.com)



# **Appendix I** Traffic Impact Assessment





# GLEN INNES SEVERN COUNCIL QUARRY TRAFFIC IMPACT ASSESSMENT

FOR

GLEN INNES SEVERN  
COUNCIL



**BITZIOS**  
consulting

**Gold Coast**  
Suite 26, 58 Riverwalk Avenue  
Robina QLD 4226  
P: (07) 5562 5377  
W: [www.bitziosconsulting.com.au](http://www.bitziosconsulting.com.au)

**Brisbane**  
Level 2, 428 Upper Edward Street  
Spring Hill QLD 4000  
P: (07) 3831 4442  
E: [admin@bitziosconsulting.com.au](mailto:admin@bitziosconsulting.com.au)

**Sydney**  
Studio 203, 3 Gladstone Street  
Newtown NSW 2042  
P: (02) 9557 6202

## DOCUMENT CONTROL SHEET

### Issue History

Report File Name	Prepared by	Reviewed by	Issued by	Date	Issued to
P2752.001R Glen Innes Severn Council Quarry TIA	N. Barnes	A. Piggott	N. Barnes	16/12/2016	Keith Appleby, via: <a href="mailto:kappleby@gisc.nsw.gov.au">kappleby@gisc.nsw.gov.au</a>
P2752.002R Glen Innes Severn Council Quarry TIA	N. Barnes	A. Eke	N. Barnes	21/12/2016	Keith Appleby, via: <a href="mailto:kappleby@gisc.nsw.gov.au">kappleby@gisc.nsw.gov.au</a>

*Copyright in the information and data in this document is the property of Bitzios Consulting. This document and its information and data is for the use of the authorised recipient and this document may not be used, copied or reproduced in whole or in part for any purpose other than for which it was supplied by Bitzios Consulting. Bitzios Consulting makes no representation, undertakes no duty and accepts no responsibility to any third party who may use or rely upon this document or its information and data.*

# CONTENTS

	Page
<b>1. INTRODUCTION .....</b>	<b>1</b>
1.1 BACKGROUND	1
1.2 CONTEXTUAL INFORMATION	1
1.3 SCOPE OF WORKS	2
<b>2. PROPOSED DEVELOPMENT .....</b>	<b>3</b>
2.1 PROJECT DESCRIPTION	3
2.2 ACCESS ARRANGEMENT	3
<b>3. TRAFFIC ASSESSMENT.....</b>	<b>4</b>
3.1 OVERVIEW	4
3.2 BACKGROUND TRAFFIC VOLUMES	4
3.2.1 2014 Background Traffic Volumes	4
3.2.2 Forecast Background Traffic Volumes	4
3.3 DEVELOPMENT TRAFFIC GENERATION AND DISTRIBUTION	5
3.3.1 Stage 1 – Short Term (i.e. Wind Farm Project Construction Period)	5
3.3.2 Stage 2 – Long Term (Post Wind Farm Project Construction Period)	7
3.4 DESIGN TRAFFIC VOLUMES	8
3.5 TRAFFIC ASSESSMENT SUMMARY	9
3.6 TURN WARRANTS ASSESSMENT	9
3.6.1 Wattlevale Access	9
3.6.2 Exit-Only Access	10
<b>4. SITE ACCESS .....</b>	<b>11</b>
<b>5. SUMMARY AND CONCLUSION.....</b>	<b>12</b>

## Tables

Table 3.1:	Stage 1 – GISC Quarry Peak Hour Traffic Volumes
Table 3.2:	Stage 1 – GIWFP Peak Hour Traffic Volumes
Table 3.3:	Stage 2 – GISC Quarry Peak Hour Traffic Volumes
Table 3.4:	Stage 1 – GIWFP Peak Hour Traffic Volumes

## Figures

Figure 1.1:	Indicative Quarry Location and Accesses
Figure 2.1:	One-Way Internal Access Arrangement
Figure 3.1:	2014 Peak Hour Traffic Volumes – Gwydir Highway fronting the Quarry
Figure 3.2:	2017 Forecast Peak Hour Traffic Volumes
Figure 3.3:	2027 Forecast Peak Hour Traffic Volumes
Figure 3.4:	Stage 1 – Development AM Peak Period Traffic Volumes (GISC Quarry + GIWFP Traffic)
Figure 3.5:	Stage 2 – Development AM Peak Period Traffic Volumes (GISC Quarry + GIWFP Traffic)
Figure 3.6:	2017 Design AM Peak Traffic Volumes (i.e. Background + Stage 1 Development Traffic)
Figure 3.7:	2027 Design AM Peak Traffic Volumes (i.e. Background + Stage 2 Development Traffic)
Figure 3.8:	2017 Design Turn Warrants Assessment

## Appendices

Appendix A:	Approved Wattlevale Access Detailed Design
Appendix B:	Proposed Exit-Only Access Detailed Design
Appendix C:	Traffic Data

## 1. INTRODUCTION

### 1.1 BACKGROUND

Glen Innes Severn Council (GISC) has requested Bitzios Consulting to undertake a Traffic Impact Assessment (TIA) for the proposed GISC Quarry located at 1296 Gwydir Highway, Glen Innes NSW on land described as Lots 253, 101, 87 and 113 on Plan DP753319. The indicative GISC Quarry location is shown in Figure 1.1.



Source: Google Earth – NSW Globe

Figure 1.1: Indicative Quarry Location and Accesses

### 1.2 CONTEXTUAL INFORMATION

The following section summarises critical information relating to following Traffic Impact Assessment.

- The Wattlevale access identified as Access 1 within Figure 1.1 has been previously approved for the Glen Innes Wind Farm Project (GIFWFP) with a Short Channelised Right-Turn (CHR(s)) and a Short Auxiliary Left-Turn treatment. Refer to the detailed design package prepared by Local Government Engineering Services (LEGS) attached in Appendix A. The upgrade construction for the access is currently subject to a Works Approval Deed (WAD) process by RMS, expected to be completed within 6 months;
- Bitzios Consulting recently completed a Traffic Management Plan (TMP) and associated Traffic Control Plans (TCPs) (dated: 30<sup>th</sup> September 2016) for the GISC Quarry to utilise the Wattlevale access in its current form (i.e. not upgraded) under a temporary access arrangement with traffic control measures. This TMP was for a total of 80 HV movements per day This TMP has been approved with comments by RMS and is currently subject to Council approval;
- Bitzios Consulting has subsequently prepared a revised TMP and TCP (dated: 13<sup>th</sup> December 2016) for the GISC Quarry to operate utilising the Wattlevale access in its current form (i.e. not upgraded) under a temporary access arrangement with traffic control measures. This revised TMP is for an increase in Heavy Vehicle (HV) movements from 80 trips/day (40 IN:40 OUT) to 120 trips/day (60 IN: 60 OUT). This is subject to RMS and Council approval; and
- It is noted that the GIFWFP will utilise Wattlevale access for entry and exit manoeuvres, once it is operational and following completion of the upgrade to the Wattlevale access to include the required turn treatments.

### 1.3 SCOPE OF WORKS

The scope of works for assessment includes:

- reviewing the newly proposed access arrangement for the GISC Quarry development (i.e. internal one way system);
- reviewing existing background traffic volumes for the Gwydir Highway;
- estimating the expected development traffic generation and determining the anticipated impacts to the Gwydir Highway;
- confirming suitability of the proposed access configurations.

For clarity, the scope of works is limited to an external traffic and access assessment.

## 2. PROPOSED DEVELOPMENT

### 2.1 PROJECT DESCRIPTION

The GISC Quarry will comprise of a Basalt Quarry located on land south of the Gwydir Highway as indicatively shown within Figure 1.1. It is understood from information provided by GISC that the Quarry operations and demands will occur over two separate stages as described below:

- **Stage 1 (Short Term)** – In the short-term the GISC Quarry is expected to provide up to 3,000 tonnes of material per day to the Sapphire Wind Farm Project (to the west) and supply material to the GIWFP via internal roadways. The external trips associated with the GISC Quarry in the short-term will be a maximum of 200 HV movements per day (100 IN:100 OUT) and 24 LV movements per day (12 IN:12 OUT) to / from the site.
- **Stage 2 (Long Term)** In the long-term (i.e. post wind farm project construction) the GISC Quarry will provide material to the greater Glen Innes area (east) resulting in a total of 80 HV trips/day (40 IN: 40 OUT) and 24 LV trips (12 IN:12 OUT) to / from the site.

It is understood from information provided by GISC that the GISC Quarry will have a design life of approximately 30 years.

### 2.2 ACCESS ARRANGEMENT

The GISC Quarry (only) will ultimately operate with a one-way internal traffic system comprising the following accesses arrangements:

- **Entry-only** via the approved Wattlevale access following its upgrade as part of the GIWFP. As noted in Section 1.2 the GIWFP will utilise the Wattlevale access for entry and exit manoeuvres once it is operational and constructed to include the required turn treatments (CHR(s)and AUL(s)); and
- **Exit-only** via a newly proposed exit-only access to the Gwydir Highway located approximately 900m west of the Wattlevale access. The exit-only access has been designed by LEGS and is attached at Appendix B and discussed in further detail in Section 4.



Figure 2.1: One-Way Internal Access Arrangement

All internal roadways linking the internal components of the site will be subject to further detailed investigations and design by a civil contractor. It is recommended that an access management plan be prepared and implemented for the GISC Quarry. It is also recommended that all truck drivers utilising the site are appropriately inducted in relation to traffic movements to / from the public road.



### 3. TRAFFIC ASSESSMENT

#### 3.1 OVERVIEW

The following traffic assessment process is outlined below:

- sourcing background traffic volumes from available survey data;
- forecasting background traffic volumes based on historical growth rates adopted in previous assessments by Bitzios Consulting along the Gwydir Highway;
- estimating development traffic generation and distribution for the various stages of assessment;
- determining design traffic volumes by combining forecast background traffic volumes and development trips for the peak construction period and the operational period of the surrounding Wind Farm projects; and
- undertaking a turn warrants assessment to confirm that the additional traffic volumes do not warrant higher order turn treatments at the Wattlevale access.

#### 3.2 BACKGROUND TRAFFIC VOLUMES

##### 3.2.1 2014 Background Traffic Volumes

Bitzios Consulting has adopted the background traffic volumes in accordance with previously approved assessments for the GIWFP (*P2249.002 Glen Innes Wind Farm TIA*). The 2014 background traffic volumes are shown in Figure 3.1.

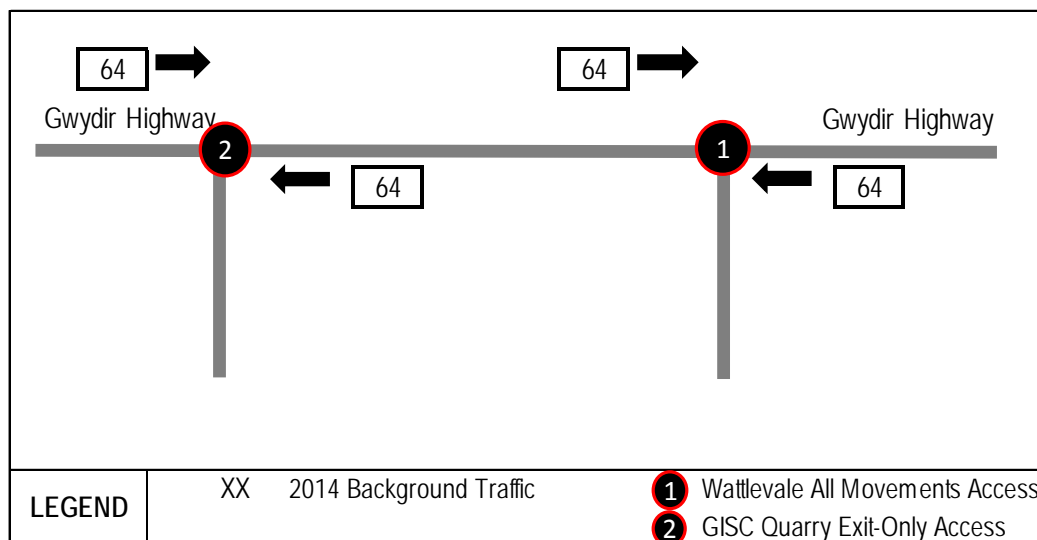

Figure 3.1: 2014 Peak Hour Traffic Volumes – Gwydir Highway fronting the Quarry

##### 3.2.2 Forecast Background Traffic Volumes

The forecast background traffic volumes have been calculated in accordance with previously approved methodology for the GIWFP (*P2249.002 Glen Innes Wind Farm TIA*).

It is understood that the GIWFP and SWFP construction periods will peak in 2017. As such, 2017 has been adopted for the purpose of Stage 1. A 10-year design horizon of 2027 has been adopted and at which time the GIWFP and SWFP will be in their operational peak period. The forecast background traffic volumes for 2017 and 2027 are shown in Figure 3.2 and Figure 3.3 respectively.

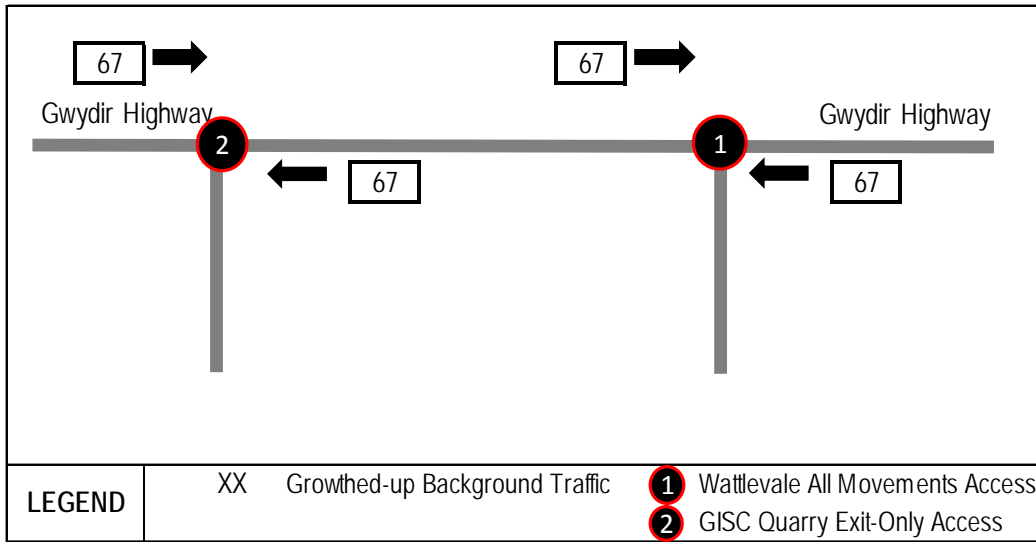

Figure 3.2: 2017 Forecast Peak Hour Traffic Volumes

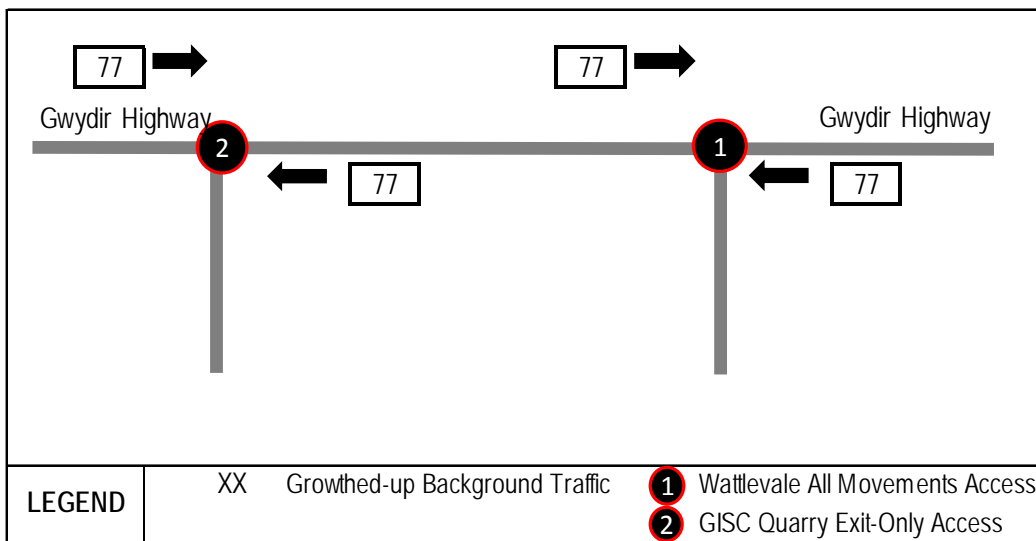

Figure 3.3: 2027 Forecast Peak Hour Traffic Volumes

As demonstrated in Figure 3.2 and Figure 3.3, the Gwydir Highway is not expected to be subject to significant background traffic volume increases over the 10-year design horizon.

### 3.3 DEVELOPMENT TRAFFIC GENERATION AND DISTRIBUTION

The traffic generation and distribution for both stages of the GISC Quarry are calculated in the following subsections.

#### 3.3.1 Stage 1 – Short Term (i.e. Wind Farm Project Construction Period)

In the short term, both the GIWFP and SWFP are assumed to be in the construction phase and supplied with material from the GISC Quarry. It is anticipated that the GISC Quarry will supply the SWFP to the west, and the GIWFP via internal roadways.

Given that the GISC Quarry will utilise the Wattlevale access for entry, the cumulative impact of the GISC Quarry and the GIWFP need to be assessed to confirm that the approved turn treatments are sufficient to accommodate the proposed traffic increase.

##### Stage 1 - GISC Quarry Traffic Generation and Distribution

The GISC Quarry is expected to generate a maximum of 200 HV movements per day (100 IN: 100 OUT) and 24 LV movements per day (12 IN: 12 OUT) (i.e. 1 IN: 1 OUT every 5 minutes).



The LV movements are assessed to occur predominantly within two critical peak periods (i.e. influx in the AM period and outflux in the PM period). The HV movements will be spread evenly throughout the 10-hour working day based on a 50% IN: 50% OUT split which equates to 10 IN: 10 OUT movements per hour (i.e. 1 IN: 1 OUT every 6 minutes). It is noted that a component of LV movements will be made throughout the day, however these traffic movements are not expected to be significant to warrant detailed analysis or trigger intersection upgrades over peak period requirements.

Table 3.1 summarises the AM and PM peak period traffic movements for the GISC Quarry development for Stage 1.

**Table 3.1: Stage 1 – GISC Quarry Peak Hour Traffic Volumes**

Vehicle Type	AM Peak Period Movements (veh/h)		PM Peak Period Movements (veh/h)	
	IN	OUT	IN	OUT
HV	10	10	10	10
LV	12	-	-	12

It is assumed for the purpose of this assessment that 50% of workers (i.e. LV users) for the GISC Quarry will be based in Glen Innes (east) and the remaining 50% based in Inverell (west).

Given that the SWFP is assumed to be the only external destination for the GISC Quarry, 100% of HV movements for the GISC Quarry will be to / from the west via the Gwydir Highway.

#### **Stage 1 - GIWFP Traffic Generation and Distribution**

The GIWFP is expected to generate a maximum of 130 HV movements per day (65 IN:65 OUT) and 80 LV movements per day (40 IN: 40 OUT) (i.e. 1 IN: 1 OUT every 1.5 minutes) (as per the previous GIWFP Traffic Impact Assessment dated 2<sup>nd</sup> February 2016).

As per the above, the LV movements are assessed to occur in AM and PM peak periods. For the purpose of this assessment it has been estimated that 40% of GIWFP HV volumes will be internal to the site (i.e. supplied material internally by the GISC Quarry) and therefore not impact the external intersections with the Gwydir Highway. This equates to a revised total of 78 movements per day using the external intersections which equates to 39 IN:39 OUT based on a 50% IN:OUT split. The HV movements will be spread evenly throughout the 10-hour working day which equates to 4 IN: 4 OUT movements per hour (i.e. 1 IN: 1 OUT every 15 minutes).

Table 3.2 details the AM and PM peak period traffic movements for the GIWFP development for Stage 1.

**Table 3.2: Stage 1 – GIWFP Peak Hour Traffic Volumes**

Vehicle Type	AM Peak Period Movements (veh/h)		PM Peak Period Movements (veh/h)	
	IN	OUT	IN	OUT
HV	4	4	4	4
LV	40	-	-	40

As per the GISC Quarry, 50% of workers (i.e. LV users) for the GIWFP are expected to be based in Glen Innes (east) and the remaining 50% based in Inverell (west).

The HV movements are also estimated to be 50% east: west split.

#### **Stage 1 Combined Traffic Volumes (GISC Quarry + GIWFP)**

The worst-case scenario is considered to be the **AM peak period** where the inbound traffic is at its highest from the Gwydir Highway. The resultant traffic volumes and the distribution to / from the site accesses in the AM peak period are summarised within Figure 3.4.

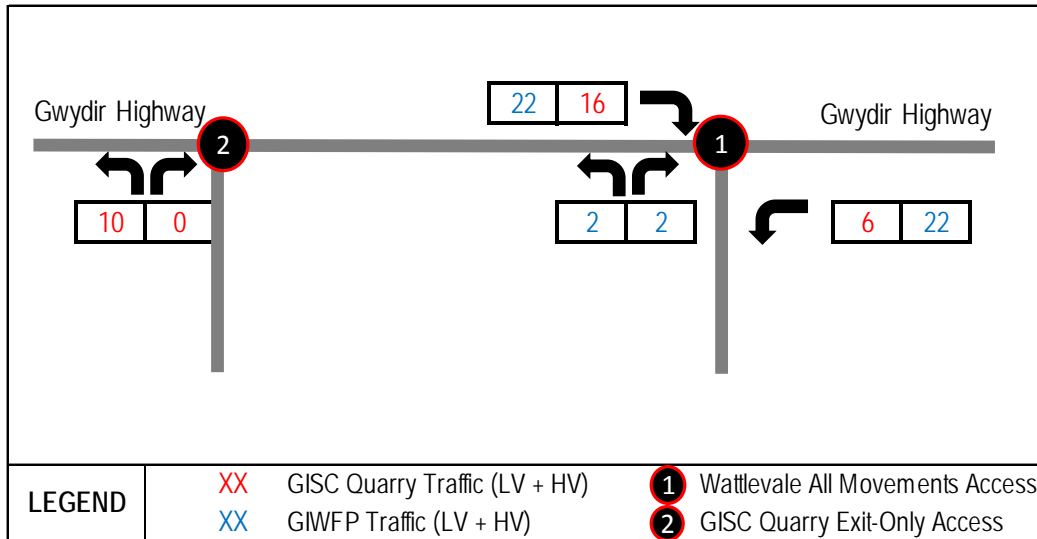

Figure 3.4: Stage 1 – Development AM Peak Period Traffic Volumes (GISC Quarry + GIWFP Traffic)

### 3.3.2 Stage 2 – Long Term (Post Wind Farm Project Construction Period)

In the long term, the GIWFP and SWFP are assumed to be in the operational phase and it is understood that the GISC Quarry will predominantly supply material to the Glen Innes area to the east.

#### Stage 2 - GISC Quarry Traffic Generation and Distribution

The GISC Quarry is expected to generate a maximum of 80 HV movements per day (40 IN: 40 OUT) and 24 LV movements per day (12 IN: 12 OUT) (i.e. 1 IN: 1 OUT every 5 minutes).

The LV movements are assumed to occur predominantly within two critical peak periods (i.e. influx in the AM period and outflux in the PM period). The HV movements are expected to be spread evenly throughout the 10-hour working day based on a 50% IN: 50% OUT split which equates to 4 IN: 4 OUT movements per hour (i.e. 1 IN: 1 OUT every 15 minutes). It is noted that a component of LV movements will be made throughout the day, however this is not expected to be a significant.

Table 3.1 summarises the AM and PM peak period traffic movements for the GISC Quarry development for Stage 1.

Table 3.3: Stage 2 – GISC Quarry Peak Hour Traffic Volumes

Vehicle Type	AM Peak Period Movements (veh/h)		PM Peak Period Movements (veh/h)	
	IN	OUT	IN	OUT
HV	4	4	4	4
LV	12	-	-	12

For the purpose of this assessment that 50% of workers (i.e. LV users) for the GISC Quarry are expected to be based in Glen Innes (east) and the remaining 50% based in Inverell (west).

In Stage 2, 100% of HV movements for the GISC Quarry are expected to be to / from the east via the Gwydir Highway.

#### Stage 2 - GIWFP Traffic Generation and Distribution

As per the previous GIWFP Traffic Impact Assessment (dated: 2<sup>nd</sup> February 2016), the traffic impact of the GIWFP is expected to be minor, involving a small number of on-site staff and periodic visits by maintenance staff as required (i.e. crane, cherry picker etc.) The traffic movements are not expected to exceed 2 to 3 IN:OUT movements per day by standard LV.

Ultimately the GIWFP is not expected to generated any significant amount of traffic during the operational phase. For the purpose of this assessment it has been assumed that a maximum of 2 IN: 2 OUT movements in the peak period (i.e. 1 IN: 1 OUT every 30 minutes).

Table 3.4 details the AM and PM peak period traffic movements for the GIWFP development for Stage 1.

**Table 3.4: Stage 1 – GIWFP Peak Hour Traffic Volumes**

Vehicle Type	AM Peak Period Movements (veh/h)		PM Peak Period Movements (veh/h)	
	IN	OUT	IN	OUT
HV	-	-	-	-
LV	2	-	-	2

As per the GISC Quarry, 50% of workers (i.e. LV users) for the GIWFP are expected to be based in Glen Innes (east) and the remaining 50% based in Inverell (west).

The HV movements are also estimated to be 50% east: west split.

**Stage 2 Combined Traffic Volumes (GISC Quarry + GIWFP)**

The worst-case scenario is considered to be the **AM peak period** where the inbound traffic is at its highest from the Gwydir Highway. The resultant traffic volumes and the distribution to / from the site accesses in the AM peak period are summarised within Figure 3.5.

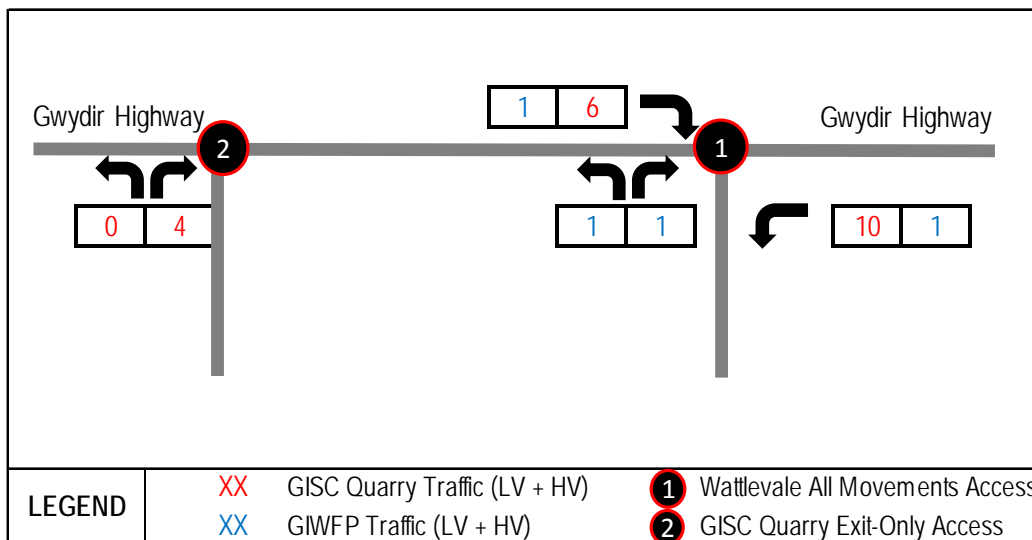

**Figure 3.5: Stage 2 – Development AM Peak Period Traffic Volumes (GISC Quarry + GIWFP Traffic)**

**3.4 DESIGN TRAFFIC VOLUMES**

It is understood that the peak construction periods for the wind farm developments will occur within 2017 and that they will be in the operational period by the 2027 design scenario. The design traffic volumes (i.e. background + development traffic) are provided in Figure 3.6 and Figure 3.7 for 2017 and 2027 design scenarios.

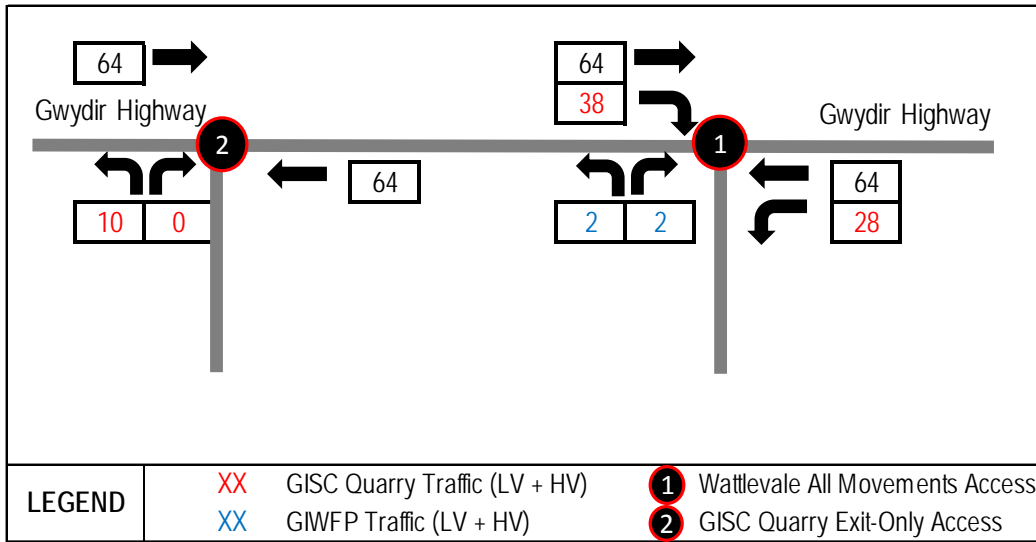

Figure 3.6: 2017 Design AM Peak Traffic Volumes (i.e. Background + Stage 1 Development Traffic)

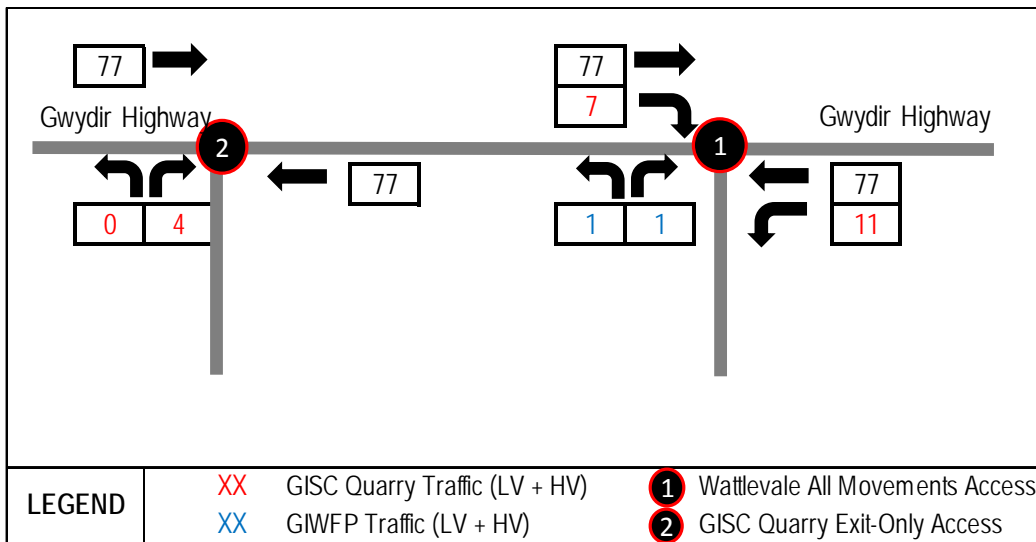

Figure 3.7: 2027 Design AM Peak Traffic Volumes (i.e. Background + Stage 2 Development Traffic)

### 3.5 TRAFFIC ASSESSMENT SUMMARY

The proposed development volumes are not substantial to impact existing or forecast background traffic volumes on the Gwydir Highway. In summary, during the AM and PM peak periods, the overall development traffic volumes equate to approximately 1 vehicle every minute entering the site and 1 vehicle every 4 minutes exiting the site.

### 3.6 TURN WARRANTS ASSESSMENT

#### 3.6.1 Wattlevale Access

In order to ensure that the approved Wattlevale access can satisfactorily accommodate the additional traffic movements associated with the GISC Quarry, a turn warrants assessment has been undertaken in accordance with the *Austrroads Guide to Road Design: Part 4A Unsignalised and Signalised Intersections*. The worst-case 2017 design traffic volumes have been adopted for the turn warrants assessments presented within Figure 3.8.

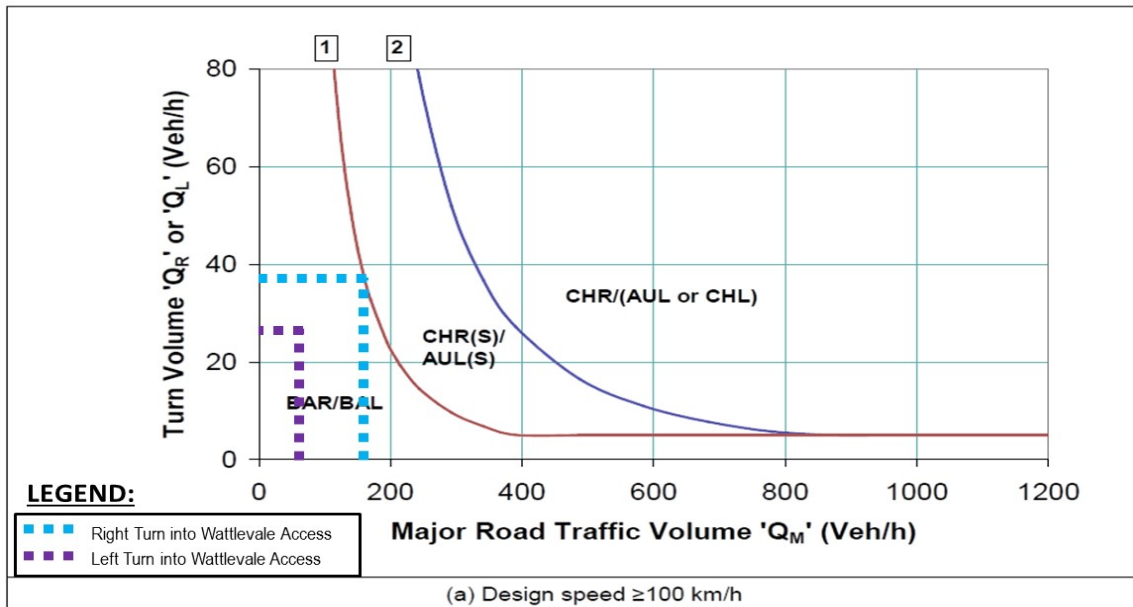

Source: Austroads Guide to Road Design Part 4A: Signalised and Unsignalised Intersections (2010) – Figure 7.5

**Figure 3.8: 2017 Design Turn Warrants Assessment**

The warrants assessment has determined that Short Channelised Right-Turn (CHR(s)) and Basic Left-Turn (BAL) treatments are warranted at the Wattlevale access based on inclusion of the GISC Quarry traffic. The approved Wattlevale access design which incorporates CHR(s) and AUL(s) treatments is therefore sufficient to cater for the additional traffic volumes.

### 3.6.2 Exit-Only Access

The exit only access does not require a turn warrants assessment as no external turn movements are applicable.

#### 4. **SITE ACCESS**

Based on the proposed access locations and the turn warrants assessment in Section 3, the access configurations from a traffic perspective will sufficiently cater for the proposed traffic volumes. Sight distance assessments and the design of functional layouts have been undertaken separately by LEGS for both accesses as attached at Appendix A and B. It is understood that the proposed accesses have been designed to accommodate the maximum design vehicles. The access designs for the Wattlevale and Exit-Only accesses are attached at Appendix A and Appendix B respectively.

It is understood that the proponent will be required to enter a Works Authorisation Deed (WAD) with RMS in order to undertake these works on the Gwydir Highway.

## 5. SUMMARY AND CONCLUSION

The key findings of the traffic impact assessment for the GISC Quarry development are as follows:

- the proposed GISC Quarry will operate in two stages as described below:
  - **Stage 1** – in the short term, the GISC Quarry will supply material to the GIWFP and the SWFP via internal roadways and the Gwydir Highway respectively. All external trips associated with the GISC Quarry will be to / from the west; and
  - **Stage 2** – in the long term (i.e. post Wind Farm Project construction) the GISC Quarry will predominantly service the Glen Innes area with all external trips to / from the east.
- the proposed GISC Quarry will ultimately operate with two access locations:
  - entry via the approved Wattlevale access for the GIWFP to be constructed following completion of a WAD process with RMS. The access will incorporate CHR(s) and AUL(s) treatments ; and
  - a newly proposed exit-only access located approximately 900m west of the approved Wattlevale access.
- the traffic generation for the GISC Quarry in Stage 1 and Stage 2 is summarised below:
  - **Stage 1** – 200 HV movements per day (i.e. 10 IN:10 OUT movements per hour) + 24 LV movements per day (i.e. 12 IN:12 OUT movements per peak hour); and
  - **Stage 2** – 80 HV movements per day (i.e. 4 IN:4 OUT movements per hour) + 24 LV movements per day (i.e. 12 IN:12 OUT movements per peak hour).
- a review of the GIWFP traffic to utilise the Wattlevale access has been undertaken based on the expectation that 40% of HV movements will be undertaken internal to the site between the GISC Quarry and the GIWFP. The resultant volumes utilised for Stage 1 and Stage 2 are summarised below:
  - **Stage 1** – 78 HV movements per day (i.e. 4 IN:4 OUT movements per hour) + 80 LV movements per day (i.e. 40 IN:40 OUT movements per peak hour); and
  - **Stage 2** – the GIWFP is not expected to generate a significant amount of traffic in the operational period. It has been conservatively assumed that a maximum of 2 IN: 2 OUT movements occur within the operational period.
- a turn warrants assessment has been undertaken for the cumulative impact of the GISC Quarry and the GIWFP traffic on the Wattlevale access and determined that the existing approved configuration will sufficiently cater for the additional traffic; and
- based on the proposed access points and the turn warrants assessment above, the access configurations from a traffic perspective will sufficiently cater for the proposed traffic volumes. Sight distance assessments and the design of functional layouts have been undertaken separately by LEGS as attached at Appendix A and B. It is understood that the accesses have been designed to accommodate the maximum design vehicles.

We conclude that there should be no major adverse impacts to the Gwydir Highway as a result of traffic associated with the proposed GISC Quarry development and that the proposed access arrangements are sufficient to cater for the proposed traffic volumes.

## APPENDIX A

### APPROVED WATTLEVALE ACCESS DETAILED DESIGN



Our Ref: IV2545

Wednesday, 14<sup>th</sup> December 2016

Senior Development Manager  
Glen Innes Wind Power  
Level 5, 39 Martin Place  
Sydney NSW 2000

Attn: Laura Tyrell

**Re: Glen Innes Wind Power Entry WAD Drawings Submission – RMS Comments**

Dear Laura,

In response to review comments received from David Pattison, RMS, by email dated 2/12/16, we have made the following amendments to the design drawings:

- Sealed shoulder has been increased to 3m between chainages 1830 and 2070 to provide a safe run-off area to compensate for the non-compliant SISD to the west, to cater for vehicles encountering a slow moving vehicle making a right turning exit into the new road, or a slow moving vehicle making a right turn entry from the new road.
- Elsewhere, sealed shoulders have been increased from 0.5 to 1m
- Merge arrows have been added at the end of the overtaking lane in accordance with AS1742.2
- Correction to line marking notations (L1 and E1)
- Superseded warning sign (W5-205) has been replaced with W5-22 truck symbolic sign.
- The pavement notes and details on sheet 6 have been updated to reflect the previous RMS comments on the geotechnical design, made in an email
- Interface drainage is required between the existing and new pavement
- Further discussion concerning the impact of the proposed design on the existing property access located on the northern frontage, opposite the termination of the O/T merge taper is given separately below.

With regard to the RMS comment (email dated 2/12/16) regarding the private property access from within the new merge area of the overtaking lane, the road safety auditors (Bitzios) have provided the following response:

- The change in environment is not considered to introduce a differential change in road safety. In fact, there may even be a slight improvement. A right turner sitting in an overtaking lane is considered to pose a higher risk than a right turner waiting at the end of a merge.
- The ability for motorists to pass a right turning vehicle still exists.
- In addition, the resident now has the ability to utilise the left turn pocket into the development and then conduct and right turn back to their site to enter via a left turn into their driveway (ie similar to a hook turn), if they feel it unsafe to do so at the end of the merge. Hence, this matter was not raised as an issue in the audit.

Therefore, no change has been made to the geometric design in this regard.

With regard to the RMS review of Geotechnical Report (RGS 30969.1-AB) and comments made by email dated 28/11/16, RGS have amended their report (RGS 30969.1-AB Rev.1 14/12/16) and we made the following amendments to the design drawings:

- The RMS requirements for a minimum acceptable pavement thickness of 450mm is noted.
- Detailed investigations were carried out at a site 850m west of this intersection, and limited investigation at this actual site. Although CBR values of 6 and 13 were found on the southern shoulder, no CBR results were taken on the northern shoulder. Therefore, as a more conservative approach, the design has been revised based on the lowest CBR of 4 encountered at the western location.
- On this basis, and considering the stated preference by RMS for the new pavement to be a granular pavement with no modification or stabilisation, a pavement thickness of 520mm has been adopted.
- An interface drain has been added between the existing and new pavement, and located below the 520mm pavement thickness, and located under the joint in the sub base layer along the line of the original edge line, with outlets to batters at spacings in accordance with RMS STD Drawings.
- Tensar grid reinforcing will be laid over this joint below the base course.
- Wearing course will be a two coat seal, and all references to AC have been removed.
- Appendix C of the Geotechnical report has been amended as follows:
  - In the recommended pavement material section – the base and sub-base are now DGB20 as per RMS spec 3051, placed in accordance with RMS spec R71. The select material shall be as per RMS spec 3071 and placed in accordance with RMS spec R44
  - References to UCS, particle size, CBR and PI information have been removed from the table.

The revised Geotechnical Report is attached, along with the updated RMS Pavement Design Checklists and Pavement Design Approval forms. These should be submitted to RMS with the drawings, along with the Road Safety Audit, and this cover letter for final WAD approval.

Yours Faithfully,



Andrew Dekkers

BE Civil, MIEAust  
Manager, Inverell  
Local Government Engineering Services



**Transport**  
Roads & Maritime  
Services

# ROADS AND MARITIME SERVICES

STATE HIGHWAY No12  
GWYDIR HIGHWAY

LGA - GLEN INNES SEVERN

## PROPOSED WINDFARM ACCESS

AT 15km WEST OF GLEN INNES

FOR GLEN INNES WIND POWER PTY LTD

### SCHEDULE OF DRAWINGS

- |   |   |    |                            |
|---|---|----|----------------------------|
| 1 | COVER SHEET                                     | 7  | ACCESS ROAD CROSS SECTIONS |
| 2 | EXISTING SITE LAYOUT, NEW SIGNAGE & LINEMARKING | 8  | ACCESS ROAD CROSS SECTIONS |
| 3 | TREATMENT GEOMETRY & SIGHT DISTANCE PROFILE     | 9  | HIGHWAY CROSS SECTIONS     |
| 4 | PROPOSED WORKS & TABLE DRAIN LONGSECTION        | 10 | HIGHWAY CROSS SECTIONS     |
| 5 | INTERSECTION GEOMETRY & LONGSECTIONS            | 11 | HIGHWAY CROSS SECTIONS     |
| 6 | TYPICAL DETAILS                                 | 12 | HIGHWAY CROSS SECTIONS     |

#### PAVEMENT

DESIGN STANDARDS  
AUSTRROADS DESIGN GUIDES  
RMS DESIGN SPECIFICATIONS  
AUSTRALIAN STANDARDS

#### DESIGN RELIABILITY

DESIGN RELIABILITY: 95%  
DESIGN PERIOD: 40 YEARS

#### TRAFFIC DATA

No OF VEHICLES PER DAY: 1332  
PERCENTAGE OF HEAVY VEHICLES: 12%  
LANE DISTRIBUTION FACTOR: 1  
ANNUAL GROWTH RATE: 1.5%

#### REFERENCE REPORTS

GEOTECHNICAL INVESTIGATION REPORT: RGS REPORT No RGS30969.1-AB

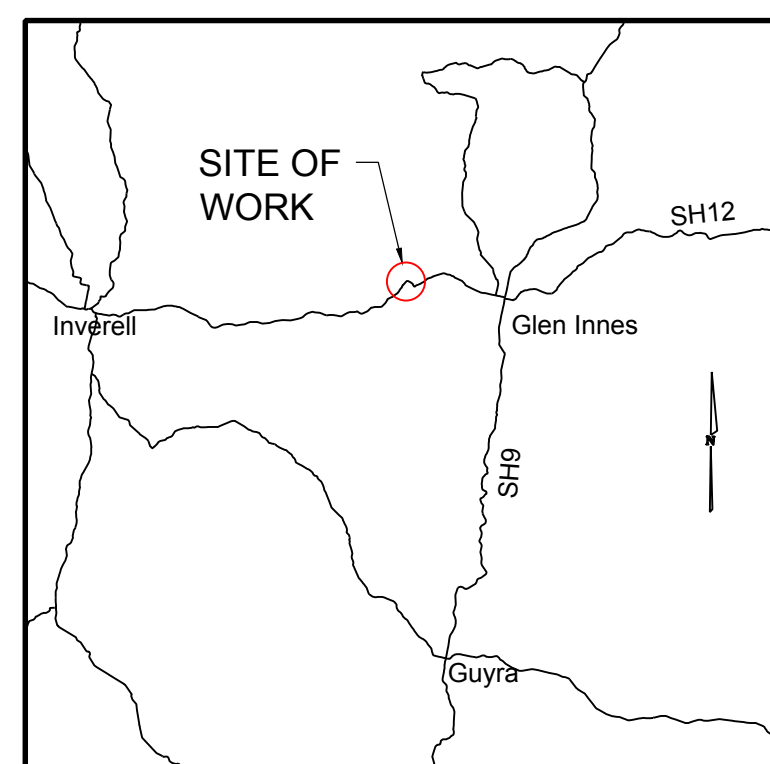

#### LOCALITY PLAN

THE SITE IS APPROXIMATELY  
630km BY ROAD FROM SYDNEY

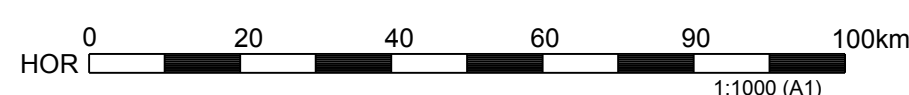

Pty Ltd ABN 64 055 099 557  
Web: www.legs.com.au  
**Port Macquarie** 69 Lord St, Port Macquarie NSW 2444  
Ph: 02-65843888 Fax: 02-65843988  
Email: john@legs.com.au  
**Inverell** 17 Byron Street, Inverell NSW 2360  
Ph: 02-67225110  
Email: andrew@legs.com.au

REGISTRATION No OF PLANS	-
ISSUE STATUS:	FOR RMS APPROVAL
SHEETS No 1	No OF SHEETS 12 ISSUE C

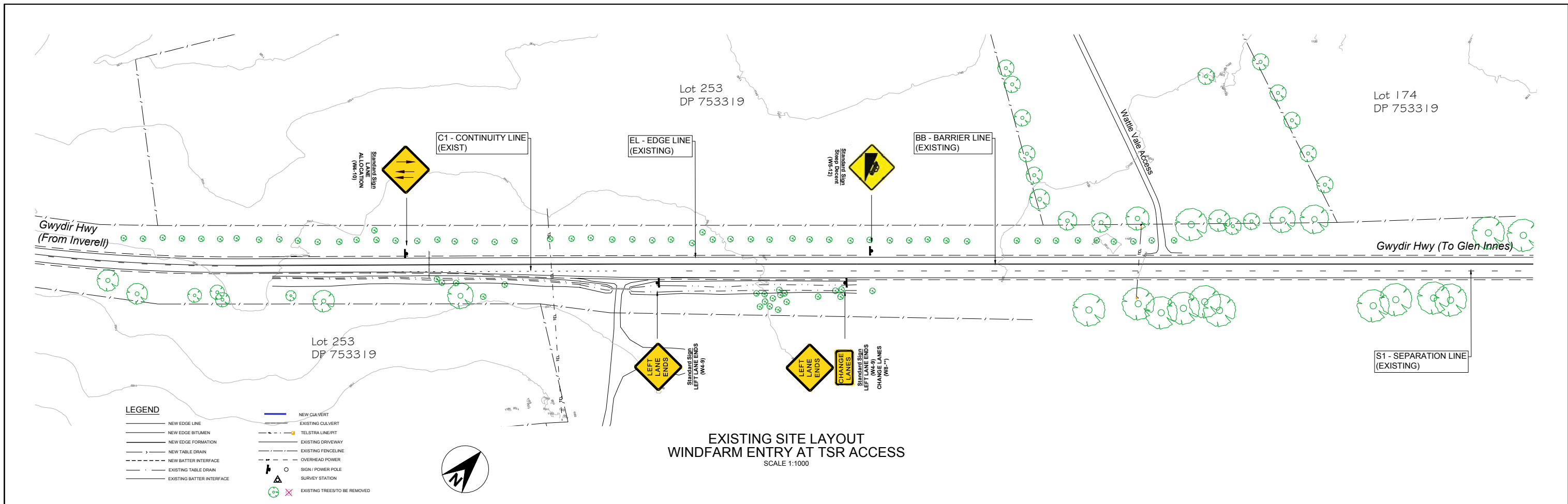

EXISTING SITE LAYOUT  
WINDFARM ENTRY AT TSR ACCESS  
SCALE 1:1000

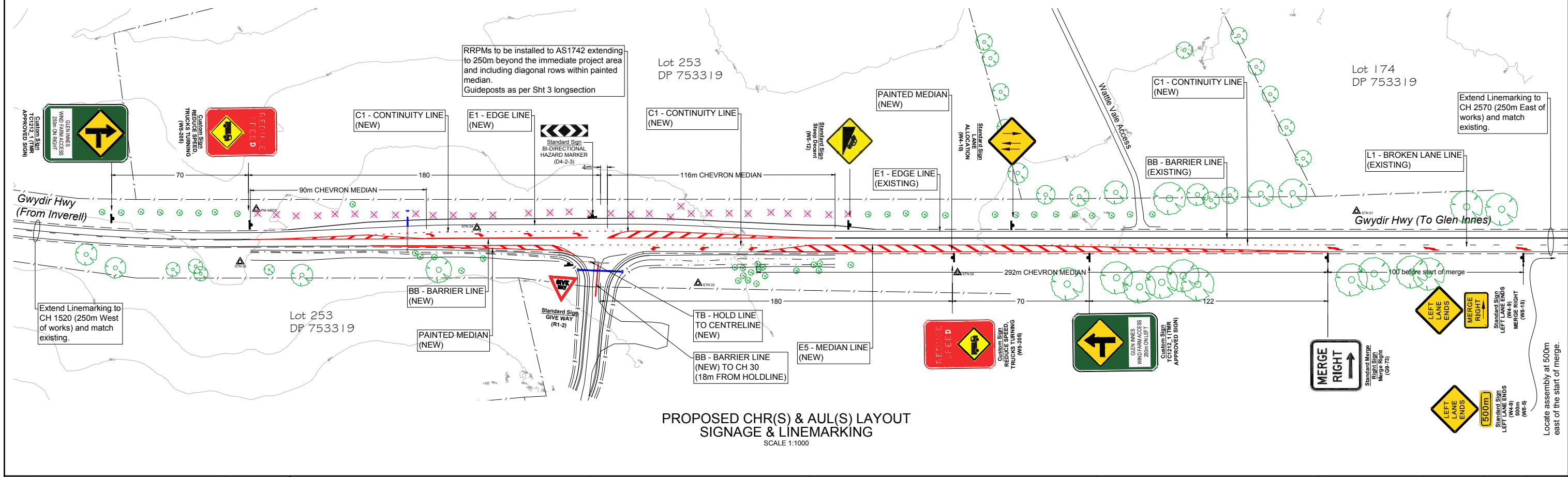

PROPOSED CHR(S) & AUL(S) LAYOUT  
SIGNAGE & LINEMARKING  
SCALE 1:1000

ISSUE	REVISION	AUTH	DATE
C	AMENDMENTS AFTER RMS REVIEW	A. D	13/12/16
B	AMENDMENTS AFTER SAFETY AUDIT	A. D	16/11/16
A	DETAILED DESIGN PLAN ISSUED FOR APPROVAL	A. D	08/10/16

**LG ES LOCAL GOVERNMENT ENGINEERING SERVICES**

Pty Ltd ABN 64 055 099 557  
Web: www.legs.com.au

Port Macquarie 69 Lord St, Port Macquarie NSW 2444  
Ph: 02-65843888 Fax: 02-65843988  
Email: john@legs.com.au

Inverell 17 Byron Street, Inverell NSW 2360  
Ph: 02-67225110  
Email: andrew@legs.com.au

CLIENT	GLEN INNES WIND POWER PTY LTD
PROJECT	PROPOSED WIND FARM ACCESS GWYDIR HWY, 15KM WEST OF GLEN INNES CHR(S) / AUL(S) Windfarm Access at TSR Gate
EXISTING SITE LAYOUT, NEW SIGNAGE & LINEMARKING	

SCALES A1 ORIGINAL

0 m 20 40 60 80 100  
Plan, Hor 1:1000 (A1) 1:2000 (A3)

DRAWN DATE MM 06/10/16  
DESIGNED DATE ASD 06/10/16  
APPROVED DATE ASD 06/10/16  
DATUM: -

JOB No.: IV2545  
DOCUMENT No.: WAD02  
STATUS: APPROVAL  
REG. No.:

SHEET No. 2 OF 12

FILE NAME: IV2545 GIWP WAD TSR Entry V2.dwg

CLIENT	GLEN INNES WIND POWER PTY LTD
PROJECT	PROPOSED WIND FARM ACCESS GWYDIR HWY, 15KM WEST OF GLEN INNES CHR(S) / AUL(S) Windfarm Access at TSR Gate
EXISTING SITE LAYOUT, NEW SIGNAGE & LINEMARKING	



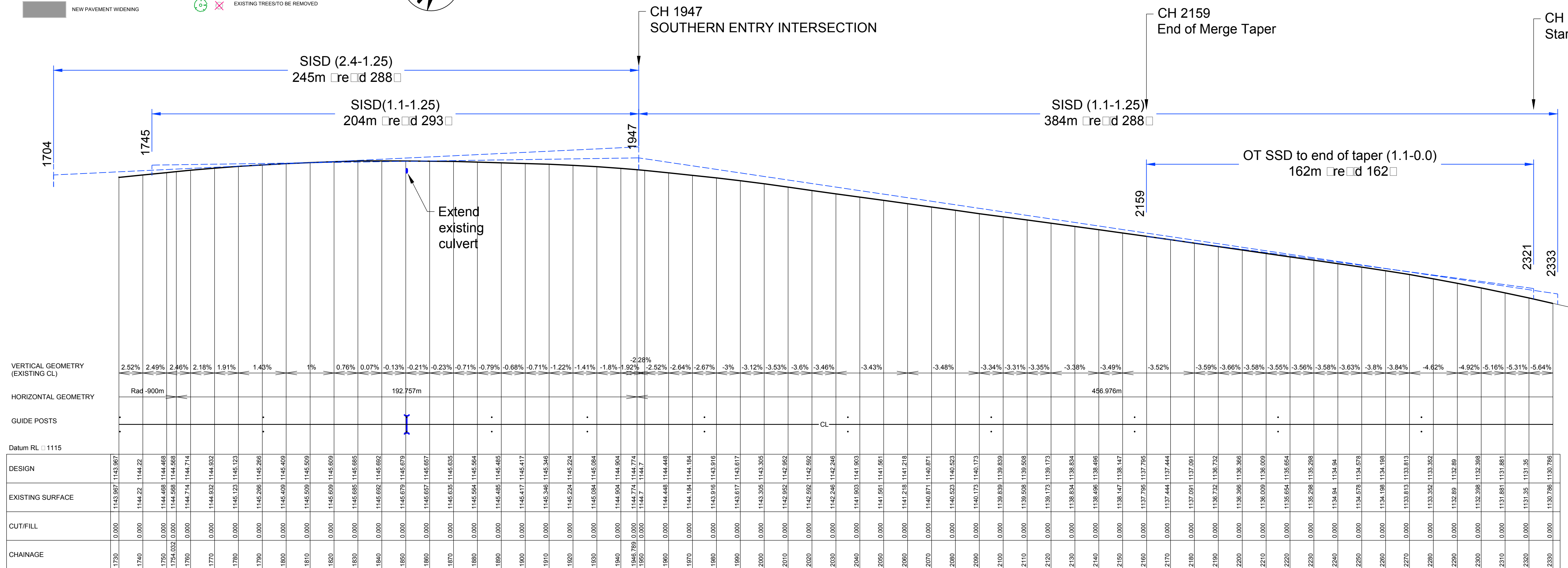
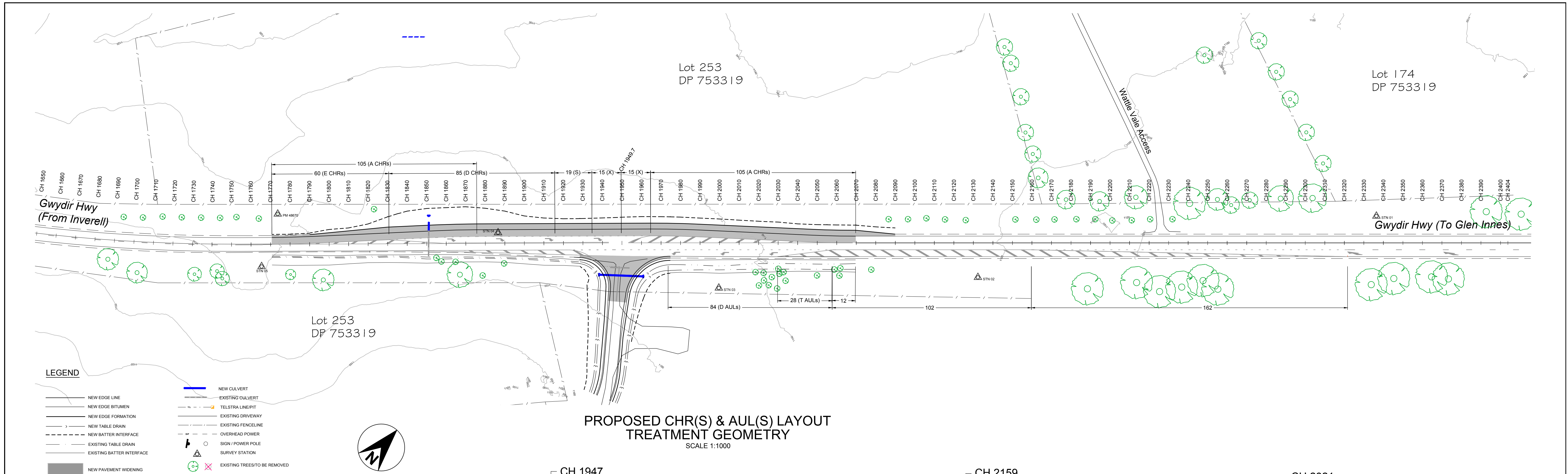

ISSUE	REVISION	AUTH	DATE
C	AMENDMENTS AFTER RMS REVIEW	A D	14/12/16
B	AMENDMENTS AFTER SAFETY AUDIT	A D	16/11/16
A	DETAILED DESIGN PLAN ISSUED FOR APPROVAL	A D	06/10/16

**LG ES LOCAL GOVERNMENT ENGINEERING SERVICES**  
Pty Ltd. ABN 64 055 099 557  
Web: www.legs.com.au

Port Macquarie: 69 Lord St, Port Macquarie NSW 2444  
Ph: 02-65843888 Fax: 02-65843988  
Email: john@legs.com.au

Inverell: 17 Byron Street, Inverell NSW 2360  
Ph: 02-67225110  
Email: andrew@legs.com.au

CLIENT: GLEN INNES WIND POWER PTY LTD

PROJECT: PROPOSED WIND FARM ACCESS  
GWYDIR HWY, 15KM WEST OF GLEN INNES  
CHR(S) / AUL(S) Windfarm Access at TSR Gate

TREATMENT GEOMETRY & SIGHT DISTANCE PROFILE

SCALES: A1 ORIGINAL

Plan: 0m 20 40 60 80 100  
Vert: 0m 5 10 15 20 25

FILE NAME: IV2545 GIWP WAD TSR Entry V2.dwg

DRAWN: ASD	DATE: 06/10/16	JOB No.: IV2545	ISSUE: C	SHEET No.: 3
DESIGNED: MM	DATE: 06/10/16	DOCUMENT No.: WAD03	STATUS: APPROVAL	OF 12
APPROVED: ASD	DATE: 06/10/16	REG. No.:		

DATUM: -

LOCATIONS SHOWN FOR COMMUNICATION SERVICES ARE INDICATIVE ONLY. IT IS THE CONTRACTORS RESPONSIBILITY TO ENSURE APPROPRIATE MEASURES ARE TAKEN TO IDENTIFY THE CORRECT LOCATION & DEPTH OF SERVICES PRIOR TO COMMENCING WORK.

**WARNING**  
EXISTING TELSTRA CABLES WITHIN FORMATION. CONFIRM LOCATION PRIOR TO EXCAVATION.

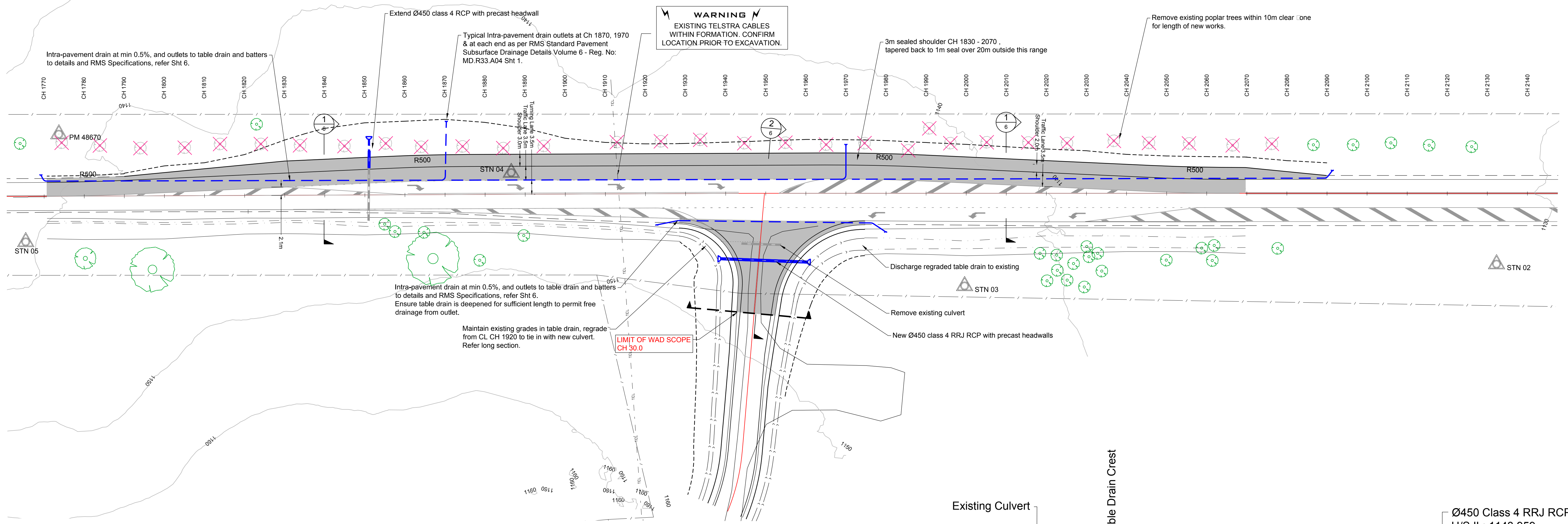

**PROPOSED WORKS**  
SCALE 1:500

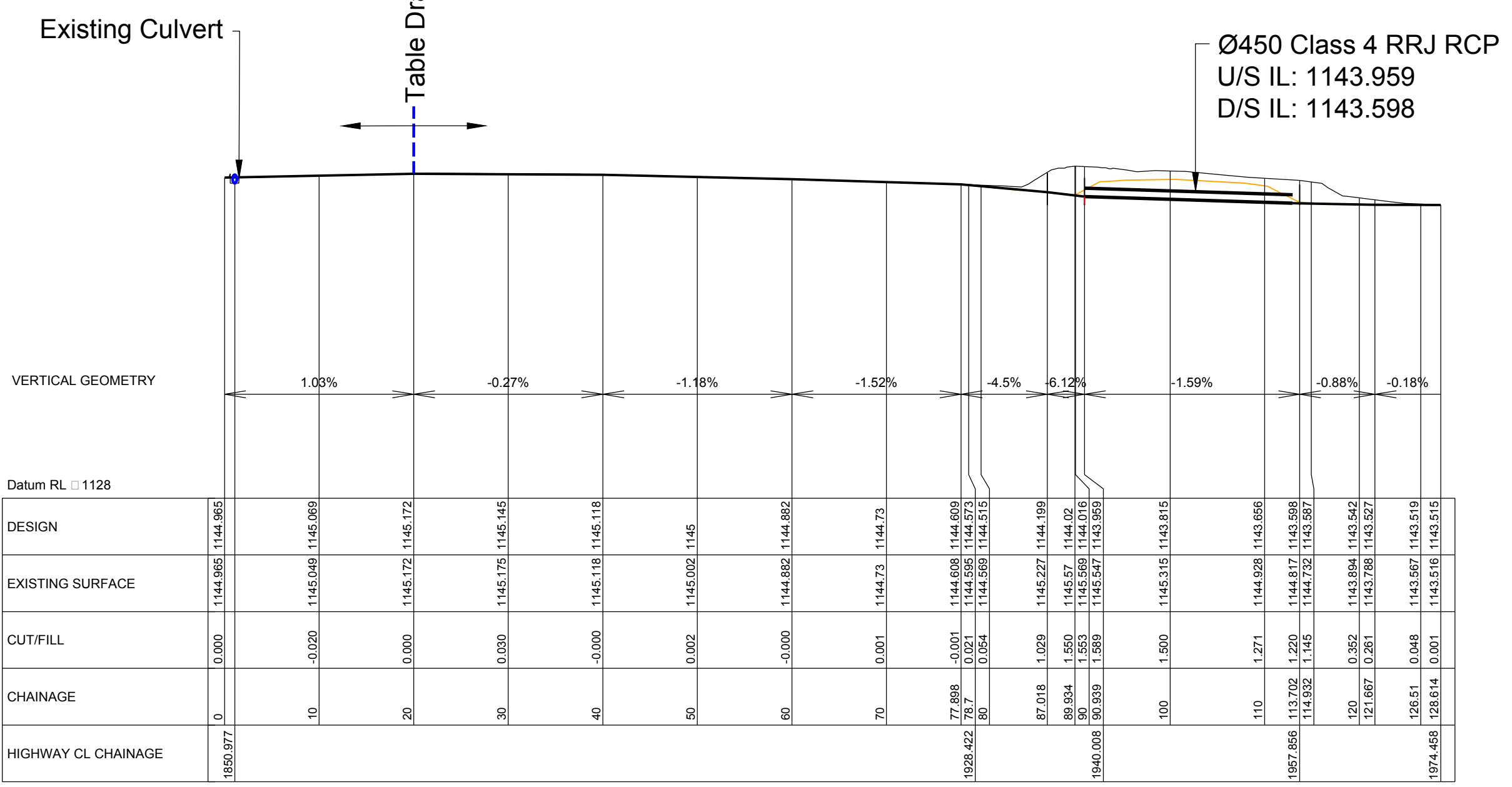

**LEGEND**

- DESIGN CENTRELINE
- NEW EDGE LINE
- NEW EDGE BITUMEN
- NEW EDGE FORMATION
- NEW TABLE DRAIN
- NEW BATTER INTERFACE
- EXISTING TABLE DRAIN
- EXISTING BATTER INTERFACE
- NEW PAVEMENT WIDENING
- NEW CULVERT
- EXISTING CULVERT
- TELSTRA LINE/PT
- EXISTING DRIVEWAY
- EXISTING FENCELINE
- OVERHEAD POWER
- SIGN / POWER POLE
- SURVEY STATION
- EXISTING TREES TO BE REMOVED

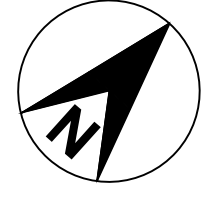

ISSUE	REVISION	AUTH	DATE
C	AMENDMENTS AFTER RMS REVIEW	A. D	14/12/16
B	AMENDMENTS AFTER SAFETY AUDIT	A. D	16/11/16
A	DETAILED DESIGN PLAN ISSUED FOR APPROVAL	A. D	06/10/16

**LG ES LOCAL GOVERNMENT ENGINEERING SERVICES**

Pty Ltd ABN 64 055 099 557  
Web: www.legs.com.au

Port Macquarie  
69 Lord St, Port Macquarie NSW 2444  
Ph: 02-65843888 Fax: 02-65843988  
Email: john@legs.com.au

Inverell  
17 Byron Street, Inverell NSW 2360  
Ph: 02-67225110  
Email: andrew@legs.com.au

CLIENT: GLEN INNES WIND POWER PTY LTD

PROJECT: PROPOSED WIND FARM ACCESS  
GWYDIR HWY, 15KM WEST OF GLEN INNES  
PROPOSED WORKS & TABLE DRAIN LONGSECTION

SCALES: A1 ORIGINAL

PLAN & HOR: 1:500 (A1) 1:1000 (A3)

Vert: 1:250 (A1) 1:500 (A3)

DRAWN: ASD DATE: 06/10/16

DESIGNED: DATE: 06/10/16

APPROVED: ASD DATE: 06/10/16

DATUM: -

JOB No.: IV2545

DOCUMENT No.: WAD04

STATUS: APPROVAL

REG. No.: -

ISSUE: C

SHEET No.: 4 OF 12

FILE NAME: IV2545 GIWP WAD TSR Entry V2.dwg



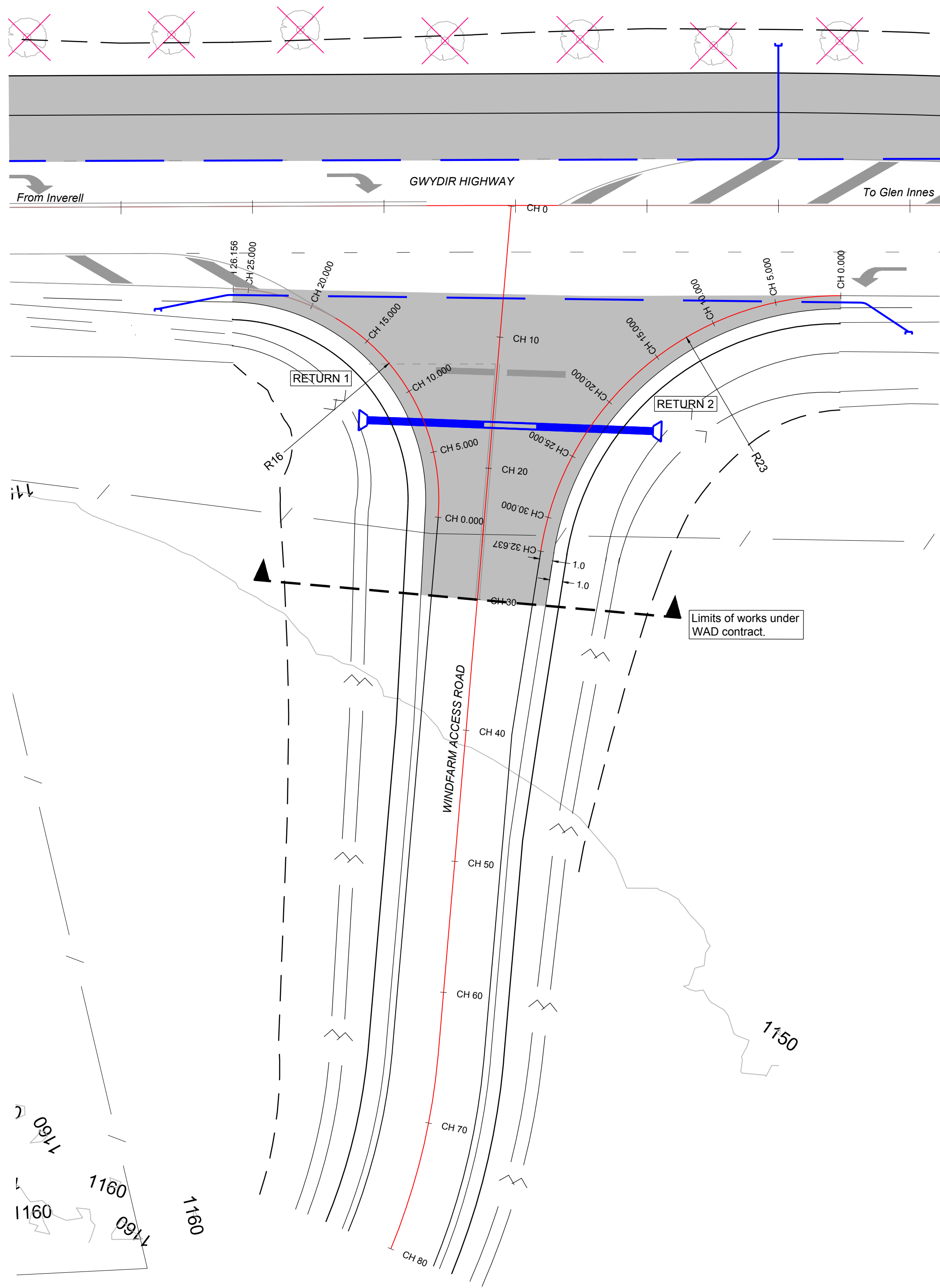

REFER SHEETS 3 AND 4 FOR LIMIT OF NEW PAVEMENT

**LEGEND**

- DESIGN CENTRELINE
- DESIGN EDGE LINE
- NEW EDGE LINE
- NEW EDGE BITUMEN
- NEW EDGE FORMATION
- NEW TABLE DRAIN
- NEW BATTER INTERFACE
- EXISTING TABLE DRAIN
- EXISTING BATTER INTERFACE
- NEW PAVEMENT WIDENING
- NEW CULVERT
- EXISTING CULVERT
- TELSTRA LINE/PIT
- EXISTING DRIVEWAY
- EXISTING FENCELINE
- OVERHEAD POWER
- SIGN / POWER POLE
- SURVEY STATION
- X EXISTING TREES/TO BE REMOVED

**WIND FARM ACCESS**  
SCALE 1:250



LONGSECTION: WINDFARM ACCESS ROAD CENTRELINE

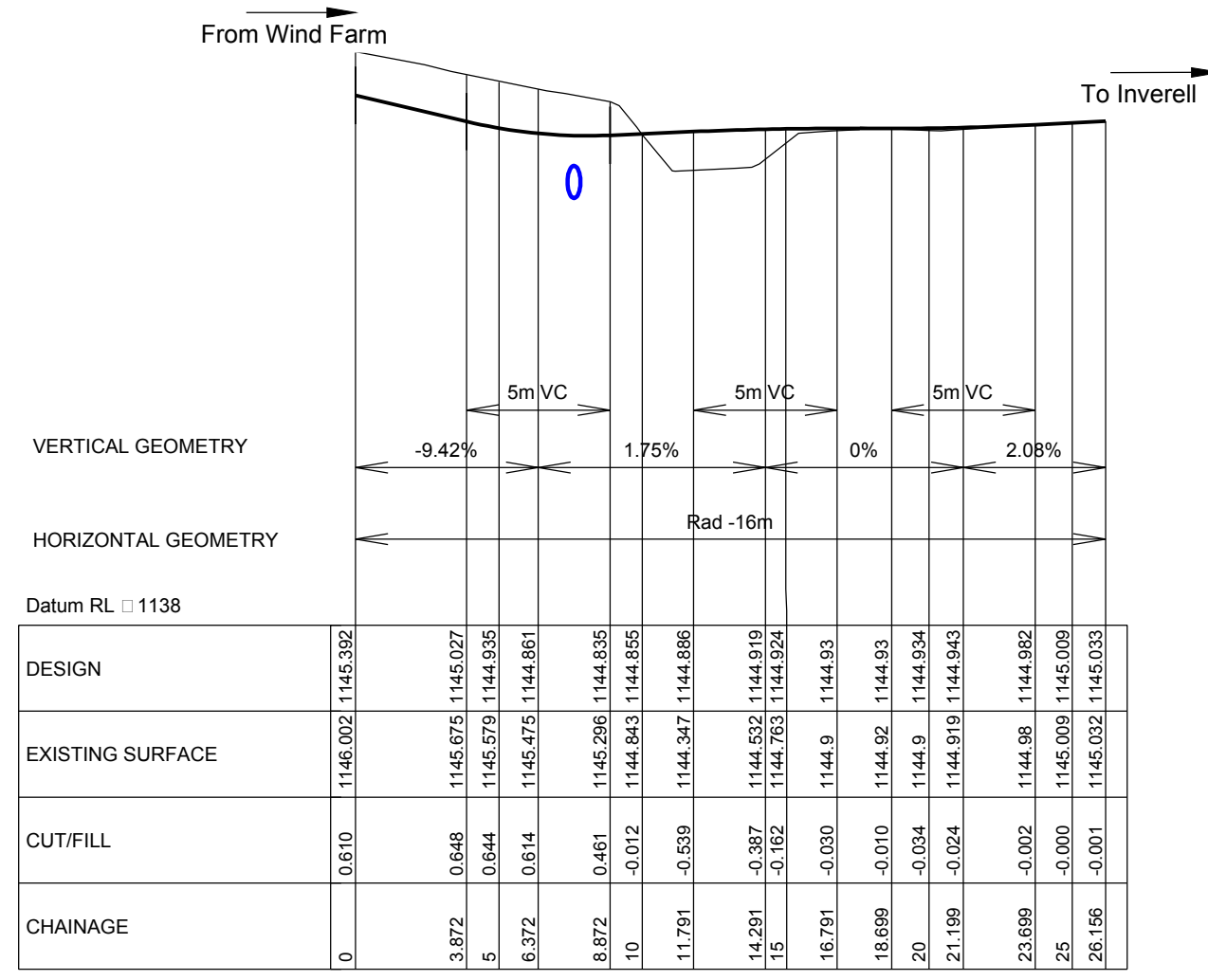

LONGSECTION: WINDFARM ACCESS ROAD RETURN 1

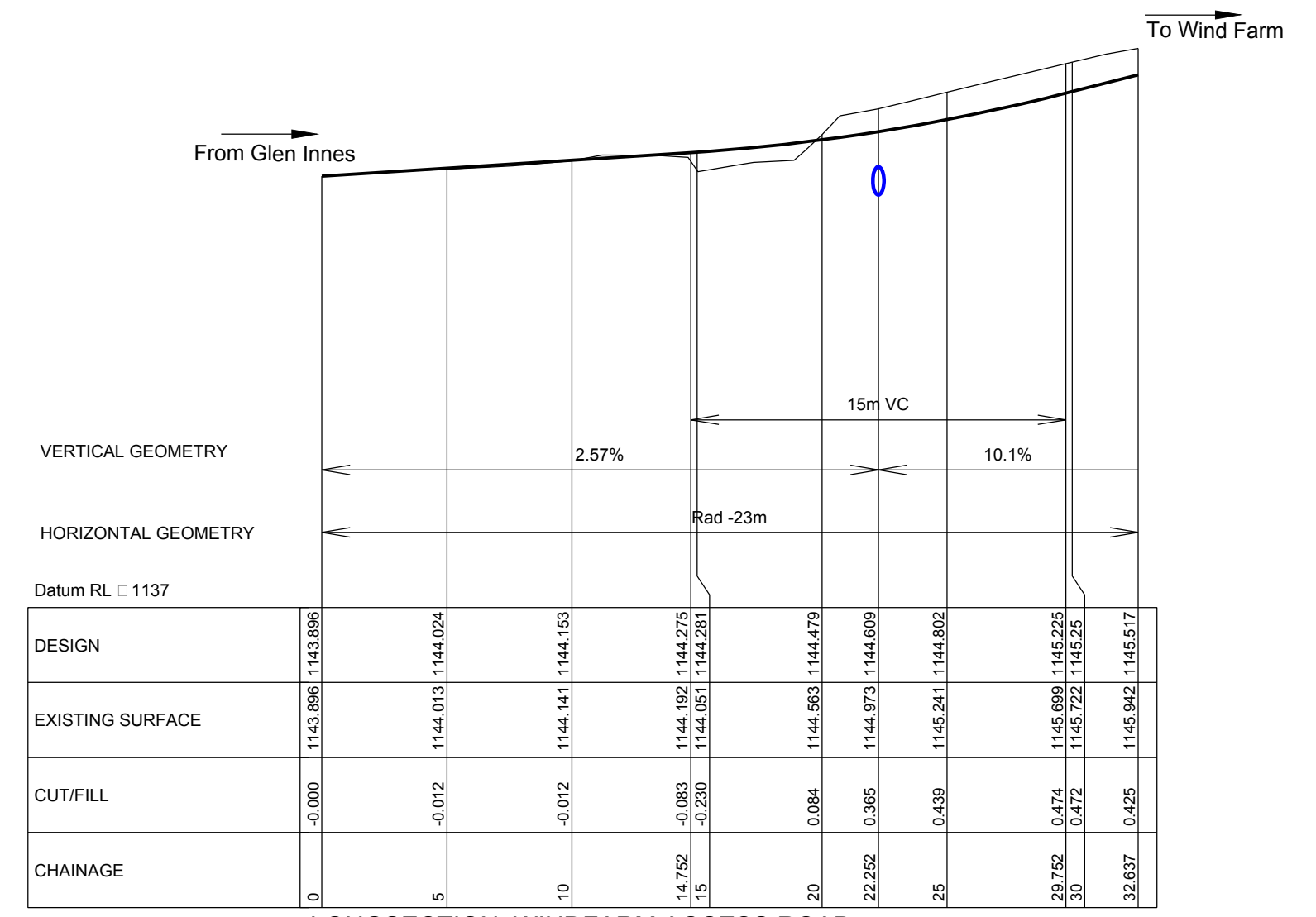

LONGSECTION: WINDFARM ACCESS ROAD RETURN 2

ISSUE	REVISION	AUTH	DATE
C	AMENDMENTS AFTER RMS REVIEW	A D	14/12/16
B	AMENDMENTS AFTER SAFETY AUDIT	A D	16/11/16
A	DETAILED DESIGN PLAN ISSUED FOR APPROVAL	A D	06/10/16

**LG ES LOCAL GOVERNMENT ENGINEERING SERVICES**  
 Pty Ltd ABN 64 055 099 557  
 Web: www.legs.com.au  
 Port Macquarie 17 Byron Street, Inverell NSW 2360  
 Ph: 02-65843888 Fax: 02-65843988  
 Email: john@legs.com.au Email: andrew@legs.com.au

CLIENT: GLEN INNES WIND POWER PTY LTD  
 PROJECT: PROPOSED WIND FARM ACCESS  
 GWYDIR HWY, 15KM WEST OF GLEN INNES  
 WINDFARM ACCESS ROAD INTERSECTION  
 LONGSECTIONS - CENTRELINE & RETURNS

SCALES: A1 ORIGINAL  
 Plan: 0m, 5, 10, 15, 20, 25  
 Plan, Hor: 0m, 10, 20, 30, 40, 50  
 DATUM: -

DRAWN: MM 06/10/16  
 DESIGNED: ASD 06/10/16  
 APPROVED: ASD 06/10/16  
 JOB No.: IV2545  
 DOCUMENT No.: WAD05  
 STATUS: APPROVAL  
 REG. No.: -  
 ISSUE: C  
 SHEET No.: 5 OF 12

FILE NAME: IV2545 GIWP WAD TSR Entry V2.dwg

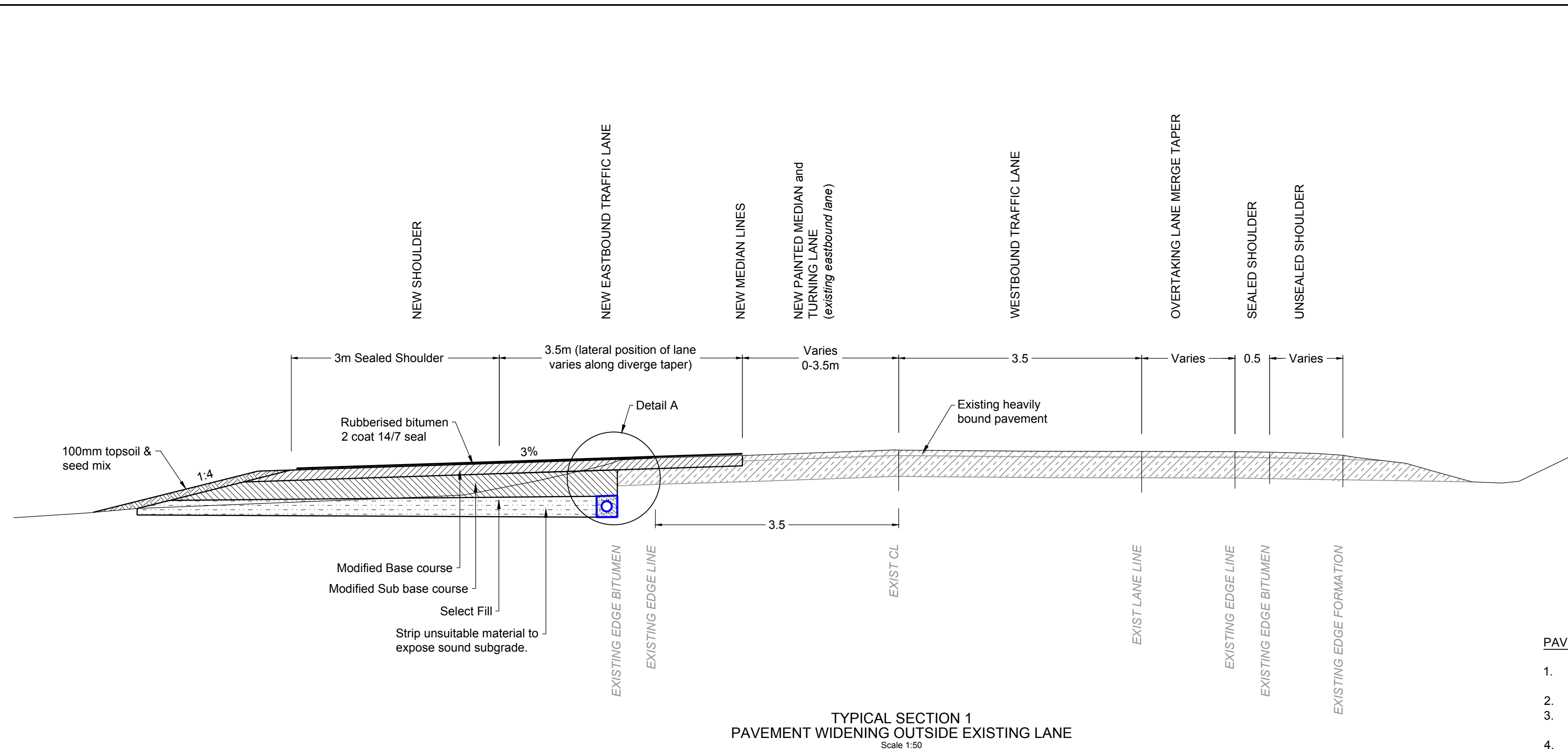

TYPICAL SECTION 1  
PAVEMENT WIDENING OUTSIDE EXISTING LANE  
Scale 1:50

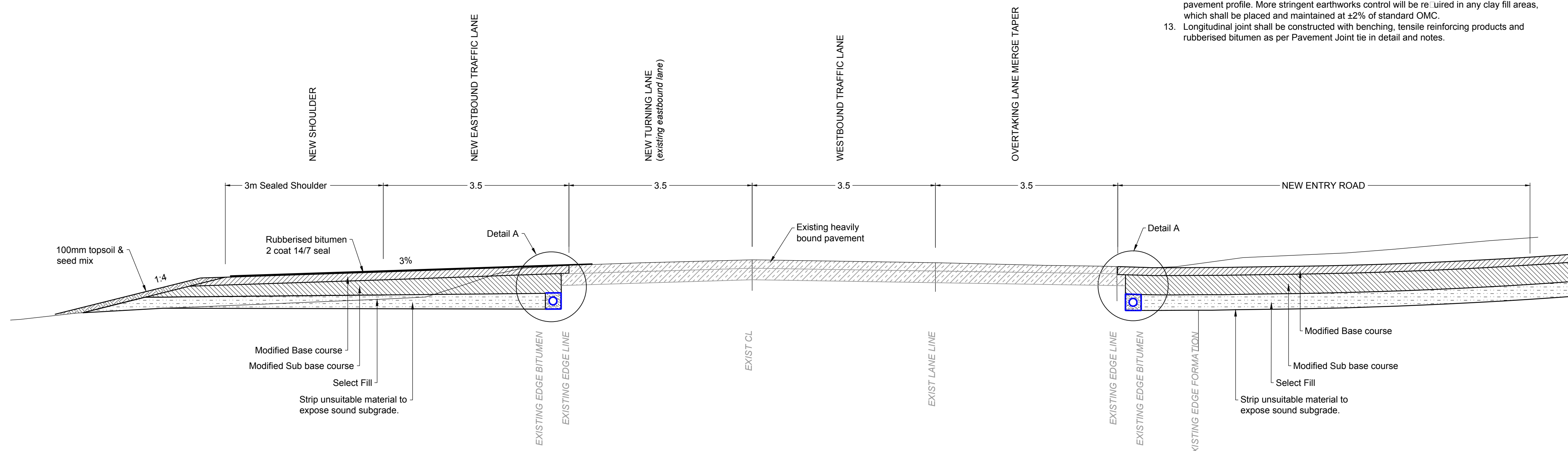

TYPICAL SECTION 2  
NEW ENTRY ROAD TIE-IN  
Scale 1:50

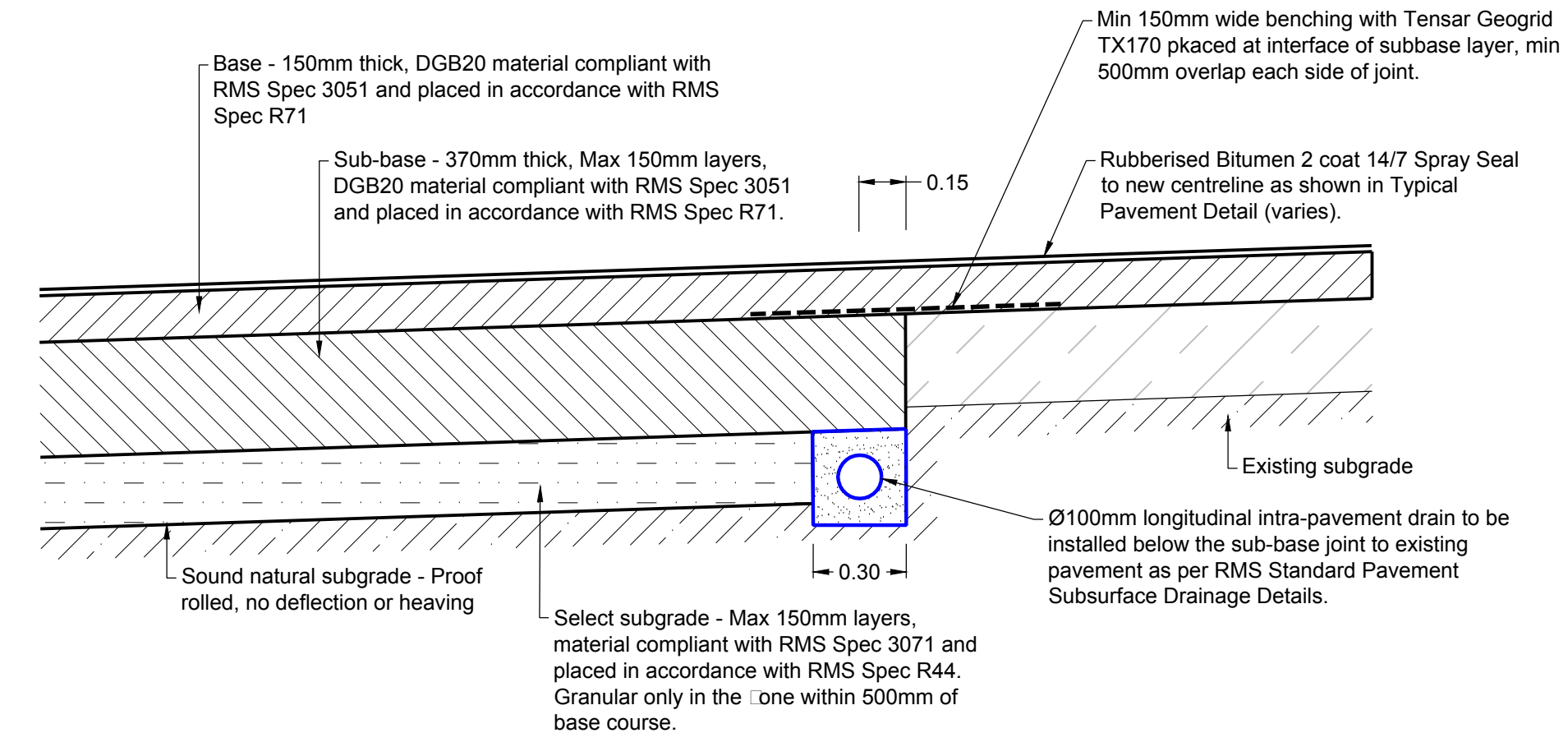

DETAIL A  
PAVEMENT JOINT TIE-IN DETAIL  
Scale 1:20

PAVEMENT NOTES

1. Pavement treatment is to be in accordance with RMS specifications and the recommendations in Regional Geotechnical Solutions report RGS30969, 1-AB Rev.1 14/12/2016
2. Remove all vegetation and relocate existing services where required.
3. Strip existing topsoil and unsuitable material from the existing verge and table drains to expose sound subgrade. Stockpile for later reuse in landscaping areas.
4. Proof roll subgrade to identify wet, excessive deflecting or heaving material. Over-excavate such material to a stiff foundation, proof roll, and have subgrade conditions verified by a geotechnical consultant.
5. All over-excavated areas shall be backfilled with clean select material.
9. Select material shall be as per RMS Spec 3071 and placed in a manner compliant with RMS Spec R44.
10. Site won materials such as existing pavement may be re-used as general fill or select fill, subject to inspection and/or testing during construction, and demonstrated compliance with the specifications.
11. Clay fill may be used EXCEPT in the top 500mm of the select fill layer below the pavement profile. More stringent earthworks control will be required in any clay fill areas.
12. Clay fill may be used EXCEPT in the top 500mm of the select fill layer below the pavement profile. More stringent earthworks control will be required in any clay fill areas, which shall be placed and maintained at 42% of standard OMC.
13. Longitudinal joint shall be constructed with benching, tensile reinforcing products and rubberised bitumen as per Pavement Joint tie in detail and notes.

PAVEMENT TIE-IN NOTES

1. Longitudinal joint shall be constructed with benching, tensile reinforcing products and rubberised bitumen as per detail.
2. Intra-pavement drainage to be installed underneath sub base joint as per RMS Standard Pavement Subsurface Drainage Details (Technical Guide and Vol 6 Standard Drawing).
3. Sawcut existing pavement along the proposed painted edge of median and continuity line, ensuring vertical face full depth of new base course.
4. Remove bound base course and any gravel below to 150mm below finished surface.
5. Along existing edge of pavement, cut and remove a minimum 370mm to subgrade level.
6. Assess subgrade and remove and replace as required, as per "Pavement Notes" up to design subgrade level.
7. Construct longitudinal subsurface intra-pavement drainage including outlet drains discharging through batters, as per Detail A and in accordance with RMS Standard Specification R37 and RMS Standard Pavement Subsurface Drainage Details Volume 6 - Supplementary Model Drawings.
8. Place and compact Sub-base.
9. Place Tensor Geogrid as per detail.
10. Place and compact Base course.
11. Place tack coat followed by Paving Fabric PF1 with minimum 500mm overlaps each side of base course joint
12. Place rubberised 2 coat spray seal with 14/7 aggregate, overlap paving fabric by min 300mm.

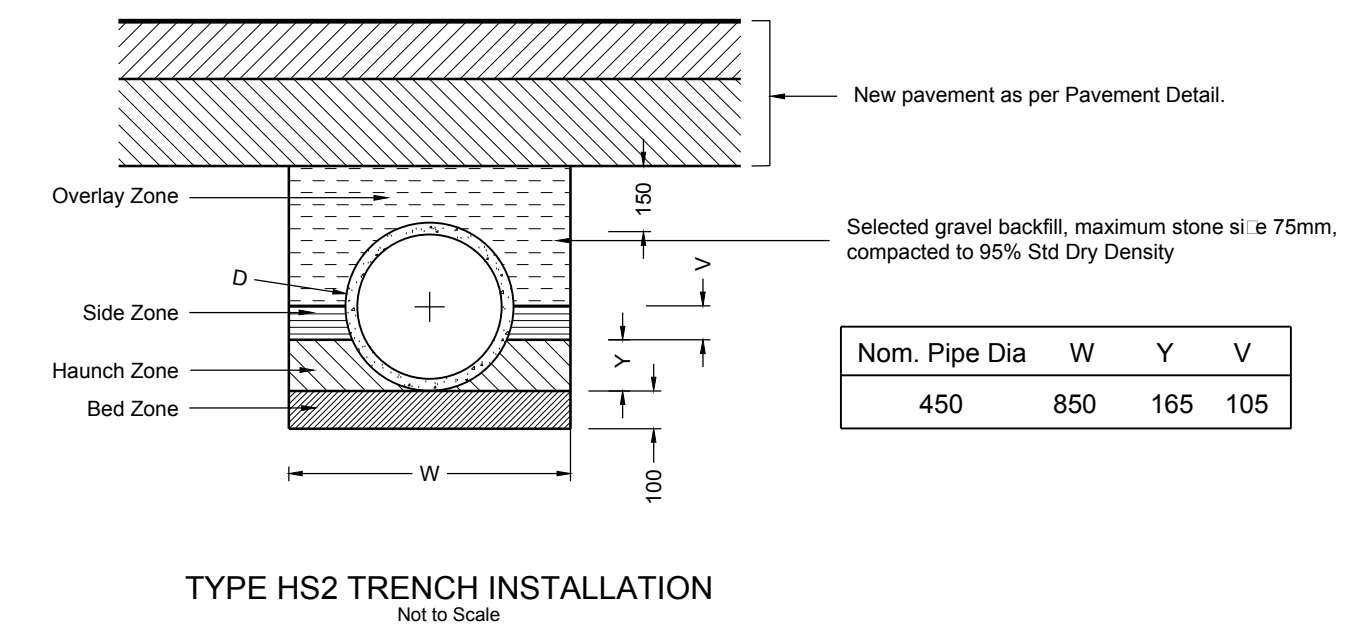

TYPE HS2 TRENCH INSTALLATION  
Not to Scale

Material Grading Requirements

Sieve Size (mm)	75.0	19.0	9.5	2.36	0.60	0.30	0.15	0.075
Bed & Haunch Zones (% mass passing)	-	100	-	100 - 50	90 - 20	60 - 10	25 - 0	10 - 0
Side Zone (% mass passing)	100	-	100 - 50	100 - 30	50 - 15	-	-	20 - 0

- Notes:
1. All bed, haunch and side zone material passing the 0.075 mm sieve to have low plasticity (AS 1726).
  2. Ordinary fill material to have no stones > 150 mm dia., and no more than 20% to be 75-150 mm.
  3. Bed, Haunch & Side Zones Min Compaction Density Index: 60%. Compact in layers 80-100mm.
  4. Side zone Relative Density (Std compaction): 90%. Compact in layers 80-100mm.
  5. Include clearance holes at socket joints

ISSUE	REVISION	AUTH	DATE
C	AMENDMENTS AFTER RMS REVIEW	A. D	14/12/16
B	AMENDMENTS AFTER SAFETY AUDIT	A. D	16/11/16
A	DETAILED DESIGN PLAN ISSUED FOR APPROVAL	A. D	06/10/16

**LG ES LOCAL GOVERNMENT ENGINEERING SERVICES**

Pty Ltd ABN 64 055 099 557  
Web: www.legs.com.au

**Port Macquarie**  
69 Lord St, Port Macquarie NSW 2444  
Ph: 02-65843888 Fax: 02-65843988  
Email: john@legs.com.au

**Inverell**  
17 Byron Street, Inverell NSW 2360  
Ph: 02-67225110  
Email: andrew@legs.com.au

CLIENT	GLEN INNES WIND POWER PTY LTD
PROJECT	PROPOSED WIND FARM ACCESS GWYDIR HWY, 15KM WEST OF GLEN INNES TYPICAL PAVEMENT DETAILS & TRENCH DETAIL

SCALES

A1 ORIGINAL

0m 1 2 3 4 5  
Detail 1:50 (A1) 1:100 (A3)

0m 0.4 0.8 1.2 1.6 2  
Detail 1:20 (A1) 1:40 (A3)

FILE NAME: IV2545 GIWP WAD TSR Entry V2.dwg

DRAWN	DATE	JOB No.:	ISSUE	SHEET No.
MM	06/10/16	IV2545	C	6
DESIGNED	DATE	DOCUMENT No.:		
ASD	06/10/16	WAD06		
APPROVED	DATE	STATUS:	APPROVAL	
ASD	06/10/16	REG. No.:		

DATUM:	-
--------	---



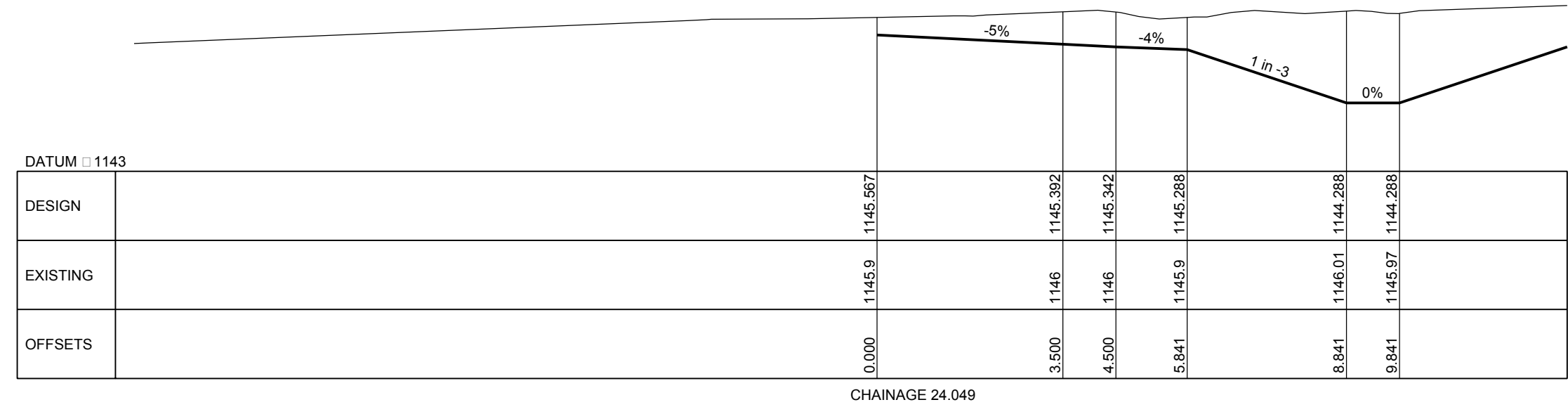
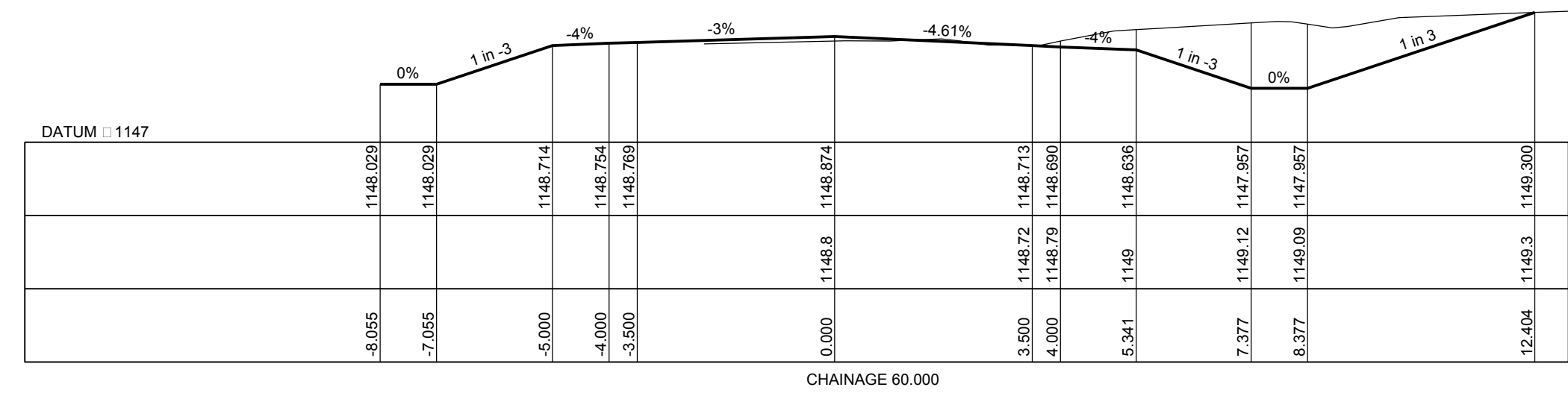
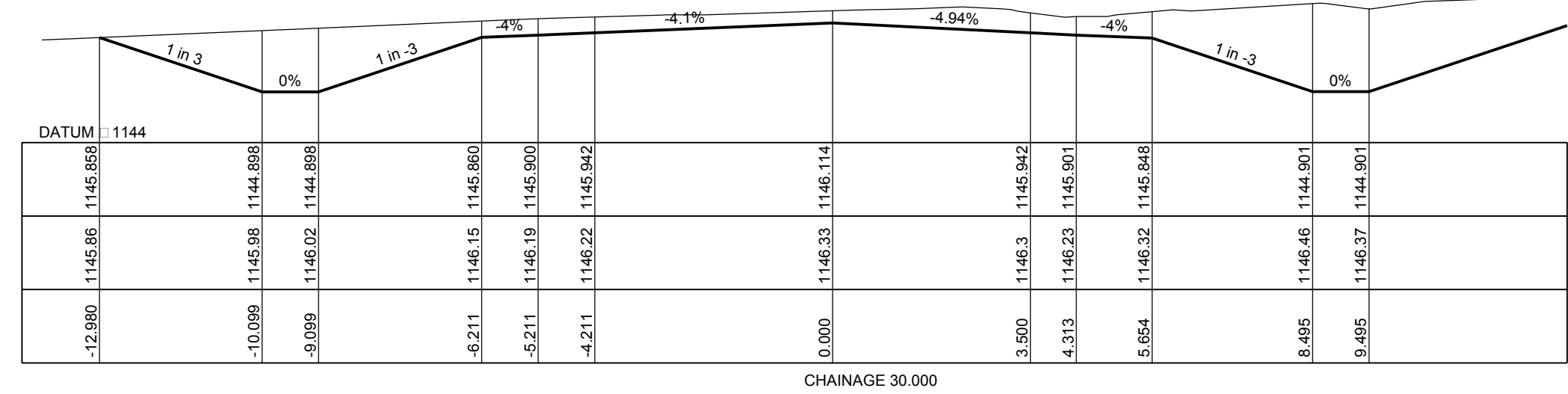
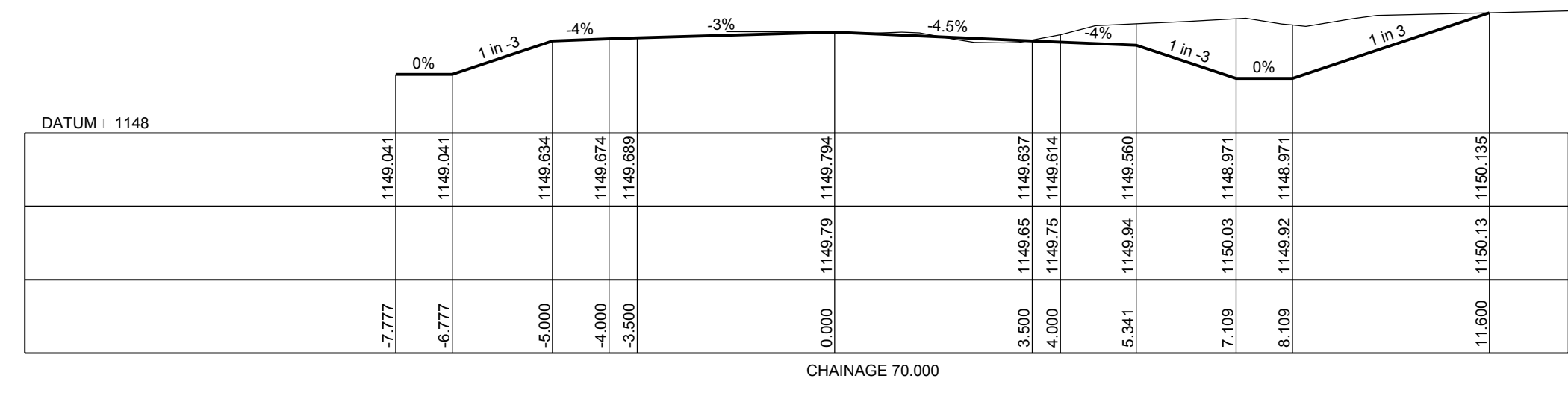
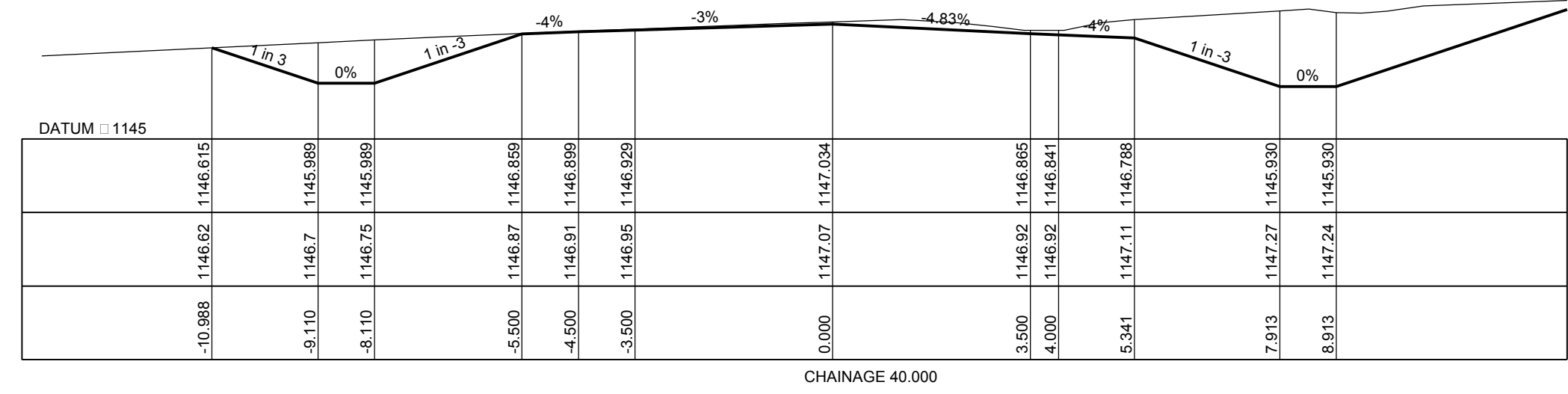
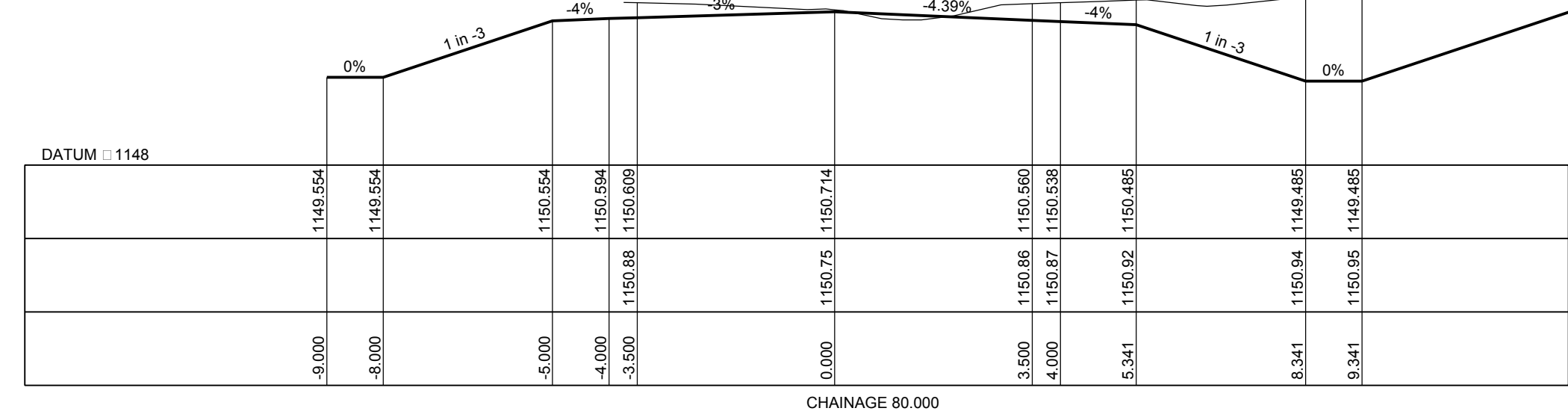
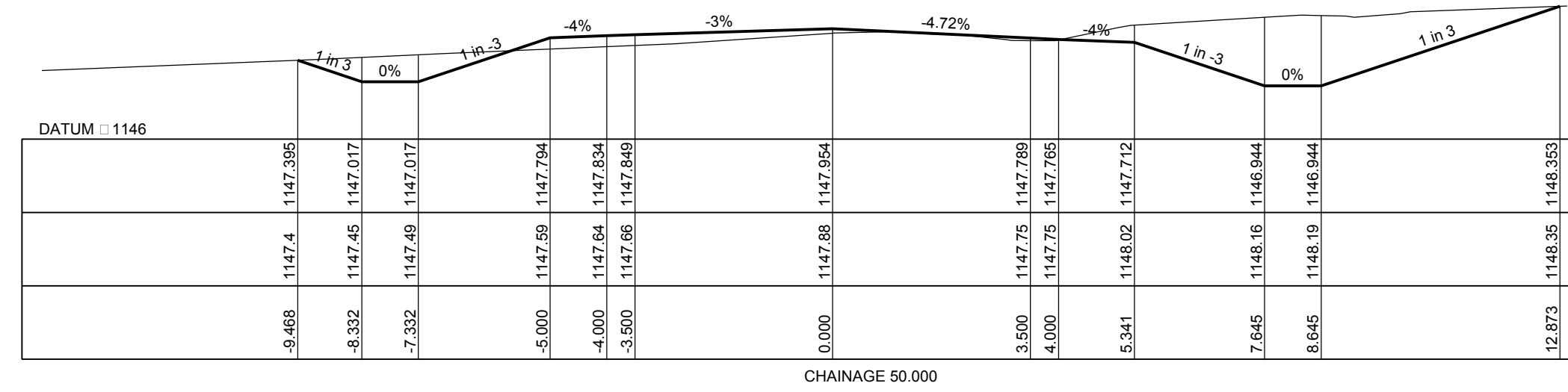

### TSR ENTRY CROSS-SECTIONS

Survey Control

STN	RL	EASTING	NORTHING
PM48670	1145.200	365845.540	6711398.510
2	1139.018	366134.513	6711613.729
3	1143.633	366039.222	6711521.233
4	1145.166	365936.060	6711466.931
5	1147.097	365857.301	6711373.315

HWY CL

CHAINAGE	RL	EASTING	NORTHING
1770.000	1144.932	365853.177	6711384.467
1780.000	1145.123	365860.604	6711391.164
1790.000	1145.266	365868.030	6711397.860
1800.000	1145.409	365875.457	6711404.556
1810.000	1145.509	365882.884	6711411.253
1820.000	1145.609	365890.311	6711417.949
1830.000	1145.685	365897.738	6711424.645
1840.000	1145.692	365905.165	6711431.342
1850.000	1145.679	365912.592	6711438.038
1860.000	1145.657	365920.019	6711444.735
1870.000	1145.635	365927.446	6711451.431
1880.000	1145.594	365934.872	6711458.127
1890.000	1145.485	365942.299	6711464.824
1900.000	1145.417	365949.726	6711471.520
1910.000	1145.346	365957.153	6711478.216
1920.000	1145.224	365964.580	6711484.913
1930.000	1145.084	365972.007	6711491.609
1940.000	1144.904	365979.434	6711498.306
1950.000	1144.700	365986.860	6711504.992
1960.000	1144.448	365994.285	6711511.657
1970.000	1144.184	366001.729	6711518.322
1980.000	1143.916	366009.234	6711524.987
1990.000	1143.617	366016.689	6711531.652
2000.000	1143.305	366024.144	6711538.318
2010.000	1142.952	366031.599	6711544.983
2020.000	1142.592	366039.054	6711551.648
2030.000	1142.246	366046.509	6711558.313
2040.000	1141.903	366053.964	6711564.978
2050.000	1141.561	366061.419	6711571.643
2060.000	1141.218	366068.874	6711578.308

Windfarm Access Road CL - Setout

CHAINAGE	RL	EASTING	NORTHING
0.000	1144.708	365986.628	6711504.775
10.000	1144.579	365992.629	6711496.776
20.000	1145.194	365998.630	6711488.777
30.000	1146.114	366004.631	6711480.778
40.000	1147.034	366010.632	6711472.779
50.000	1147.954	366016.633	6711464.780
60.000	1148.874	366022.634	6711456.781
70.000	1149.794	366028.635	6711448.782
80.000	1150.714	366034.636	6711439.783

Access Road Return 1 - Setout

CHAINAGE	RL	EASTING	NORTHING
0.000	1144.935	365998.260	6711483.438
5.000	1144.855	365994.688	6711486.907
10.000	1144.824	365990.223	6711489.111
15.000	1144.924	365985.296	6711489.835
20.000	1144.934	365980.385	6711489.009
25.000	1145.009	365975.968	6711486.714

Access Road Return 2 - Setout

CHAINAGE	RL	EASTING	NORTHING
0.000	1143.896	366009.856	6711516.406
5.000	1144.024	366006.503	6711512.711
10.000	1144.153	366004.025	6711508.379
15.000	1144.296	366002.540	6711503.615
20.000	1144.523	366002.117	6711498.643
25.000	1144.844	366002.777	6711493.697
30.000	1145.260	366004.488	6711489.009

Access Road Culvert - Setout

STN	RL	EASTING	NORTHING
U/S	1143.959	365989.321	6711485.355
D/S	1143.598	366006.067	6711499.207

#### SURVEY NOTES:

1. THIS SURVEY HAS BEEN CONDUCTED TO OBTAIN TOPOGRAPHICAL DETAIL AND LEVELS FOR THE PURPOSE OF ROAD DESIGN. THE INFORMATION SHOWN HEREIN IS ONLY RELIABLE FOR THIS PURPOSE AND SHOULD NOT BE USED FOR OTHER PURPOSE OR AT A LATER DATE WITHOUT VERIFICATION.

2. SURVEY IS ON MGA GRID DISTANCES AND AHD LEVELS. MEAN C.S.F. 0.999636 SURVEY HAS BEEN LINKED TO COORDINATES PROVIDED BY "AIRMAR 3D" FOR THE PURPOSE OF COORDINATING LIDAR/PHOTOGRAMMETRY WITH THE SURVEY. GIVEN COORDINATES:

PM 48670 (SCIMS):

E 365845.540  
N 6711398.510  
RL 1145.200

STN 1 - TEMPORARY CONTROL POINT

E 365308.035  
N 6711511.536  
RL 1136.312

3. FENCILINES SHOWN ARE INDICATIVE OF POSITION ONLY AND DO NOT REFLECT CADASTRAL BOUNDARIES. RECOMMEND FORMAL VERIFICATION OF BOUNDARIES WHERE ANY ROAD REALIGNMENT IS TO TAKE PLACE.

4. SERVICE LOCATIONS SHOWN ARE FROM SURFACE INVESTIGATIONS ONLY. WHERE SERVICE INFORMATION IS CRITICAL TO THE DESIGN PROPOSED, THE INFORMATION SHOULD BE VERIFIED PRIOR TO COMMENCEMENT OF CONSTRUCTION. ALL PARTIES SHOULD CARRY OUT THEIR OWN DIAL BEFORE YOU DIG SEARCH PRIOR TO COMMENCING ANY WORK ON SITE.

5. ALL SYMBOLS SHOWN ARE DIAGRAMMATIC ONLY AND NOT TO SCALE. TREE DIMENSIONS STIPULATED ARE DIAMETERS.

6. THIS NOTE IS AN INTEGRAL PART OF THIS PLAN.

ISSUE	REVISION	AUTH	DATE
C	AMENDMENTS AFTER RMS REVIEW	A. D	14/12/16
B	AMENDMENTS AFTER SAFETY AUDIT	A. D	16/11/16
A	DETAILED DESIGN PLAN ISSUED FOR APPROVAL	A. D	06/10/16

**LG ES LOCAL GOVERNMENT ENGINEERING SERVICES**  
 Pty Ltd ABN 64 055 099 557 Web: www.legs.com.au  
 Port Macquarie Inverell  
 69 Lord St, Port Macquarie NSW 2444 17 Byron Street, Inverell NSW 2360  
 Ph: 02-65843888 Fax: 02-65843988 Ph: 02-67225110  
 Email: john@legs.com.au Email: andrew@legs.com.au

CLIENT: GLEN INNES WIND POWER PTY LTD  
 PROJECT: PROPOSED WIND FARM ACCESS GWDYDIR HWY, 15KM WEST OF GLEN INNES  
 WINDFARM ACCESS ROAD CROSS SECTIONS AND SETOUT COORDINATES

SCALES: A1 ORIGINAL  
  
 DRAWN: MM 06/10/16  
 DESIGNED: ASD 06/10/16  
 APPROVED: ASD 06/10/16  
 DATUM: -  
 FILE NAME: IV2545 GIWP WAD TSR Entry V2.dwg

JOB No.: IV2545  
 DOCUMENT No.: WAD07  
 STATUS: APPROVAL  
 REG. No.:  
 ISSUE: C  
 SHEET No.: 7 OF 12

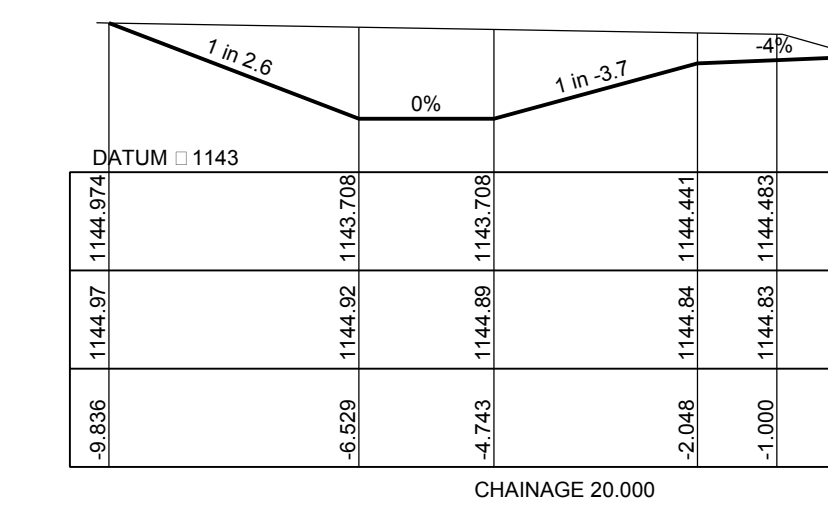
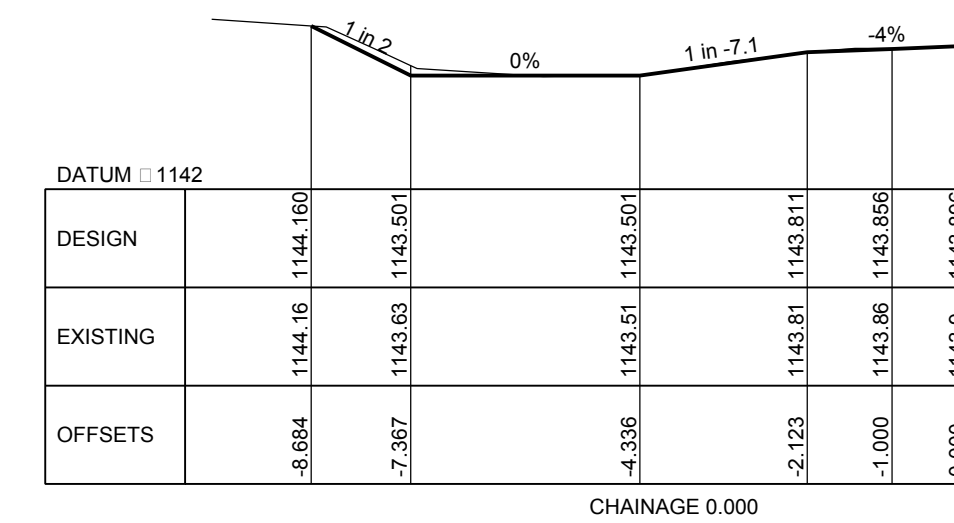
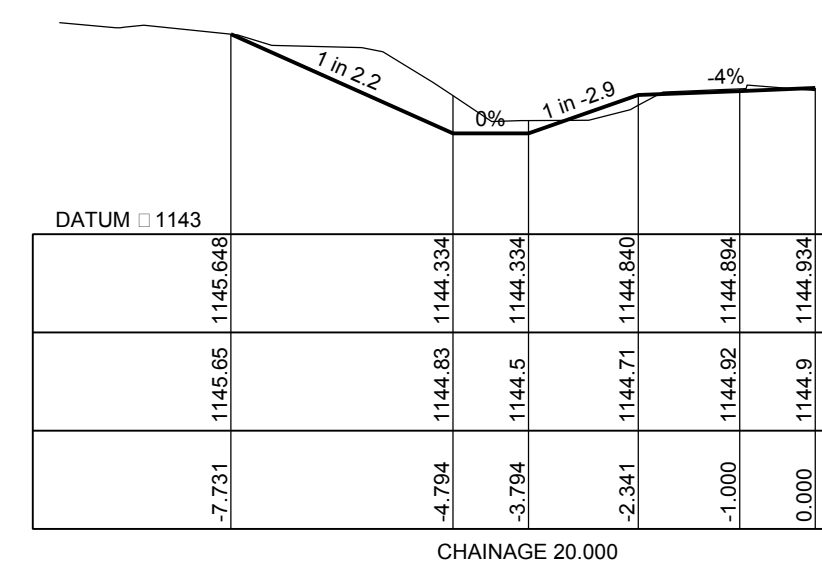
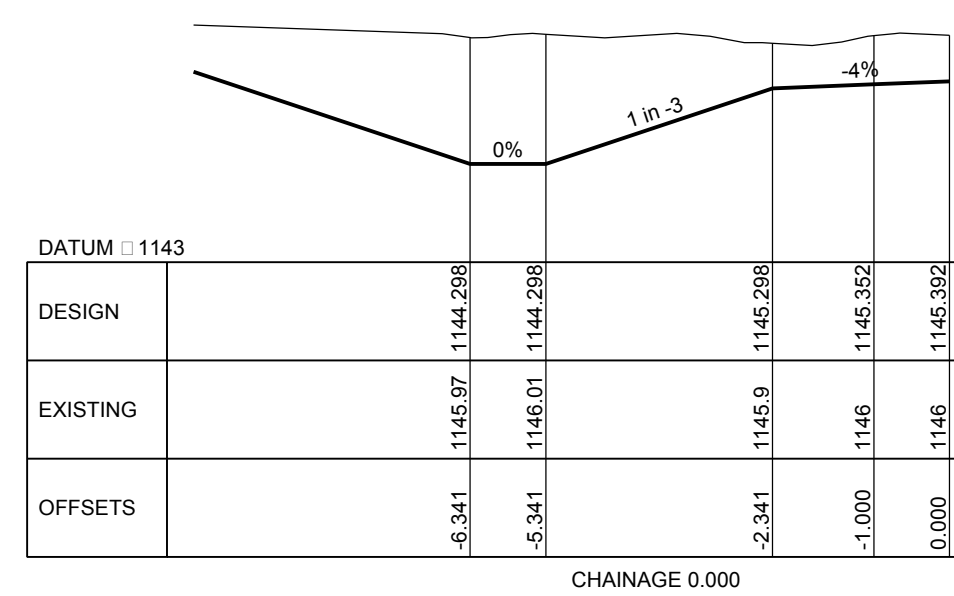
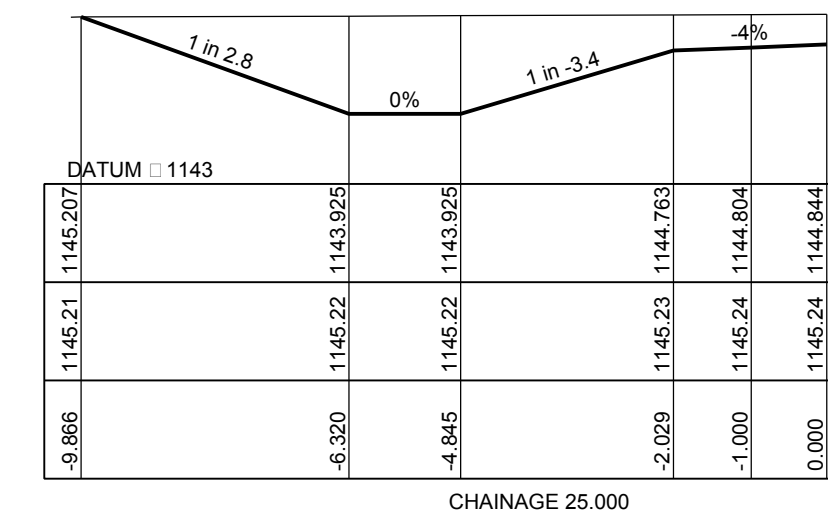
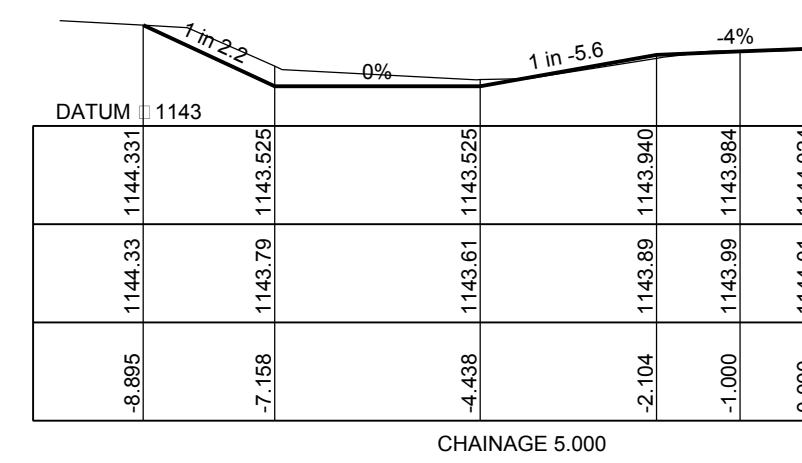
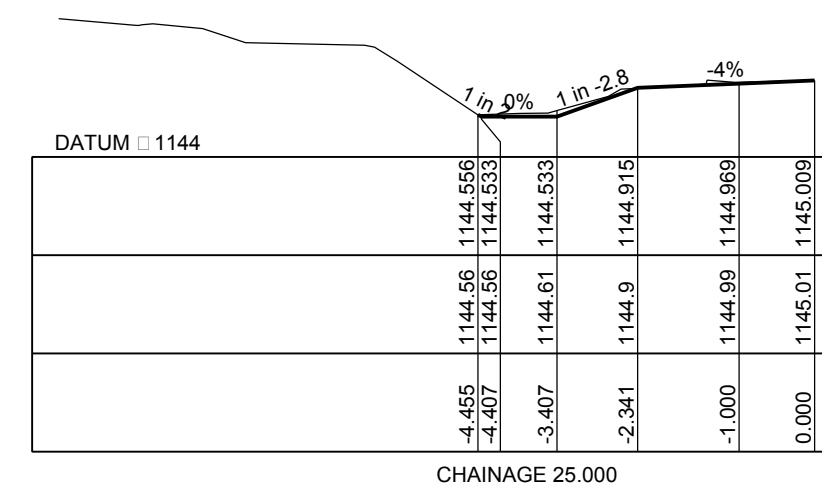
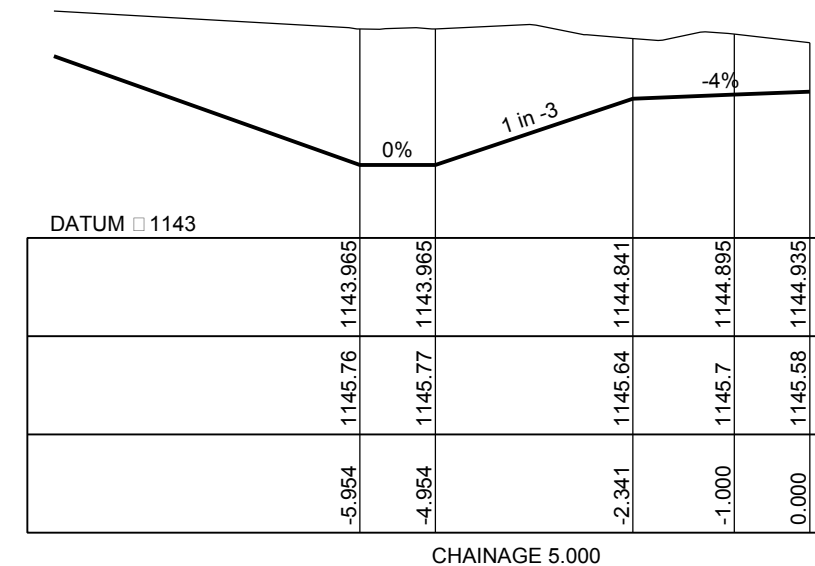
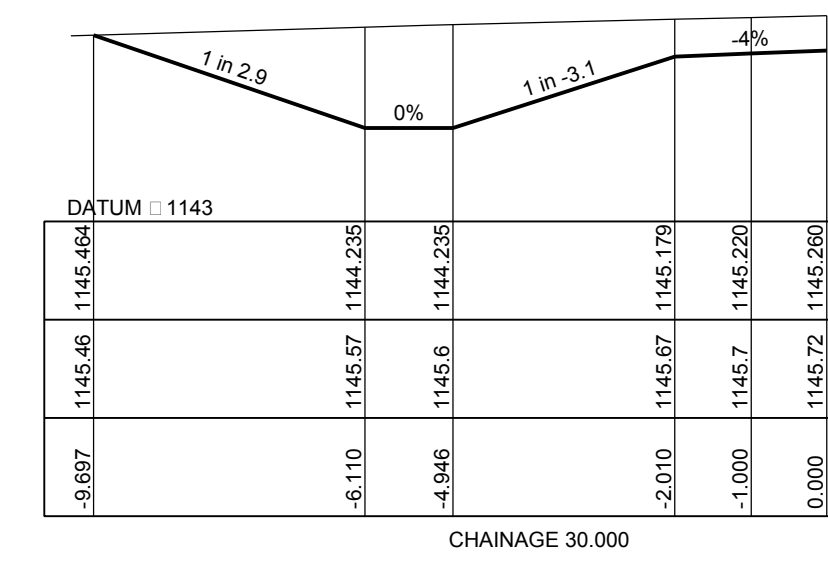
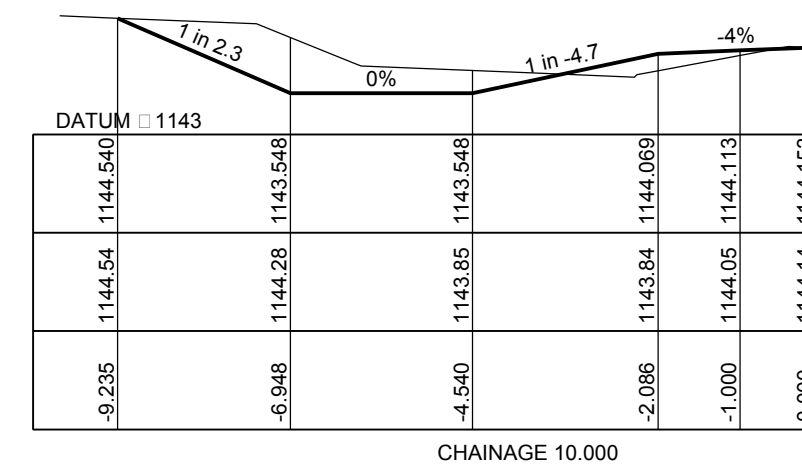
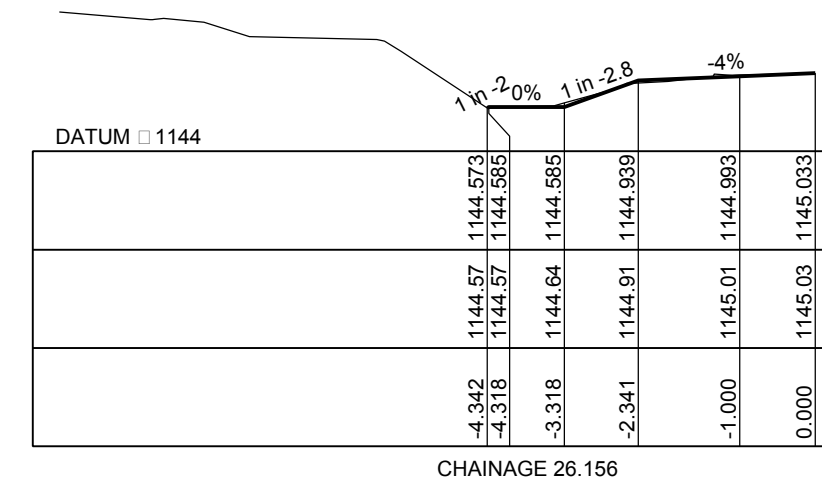
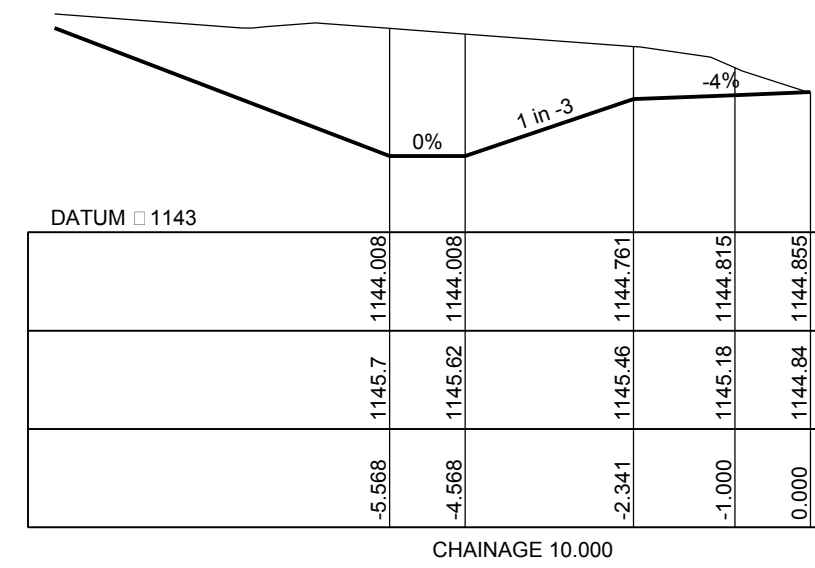
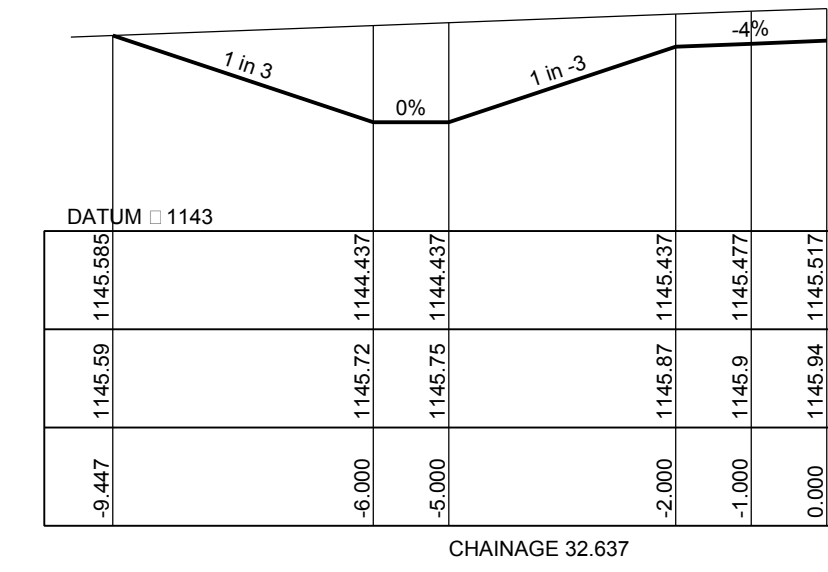
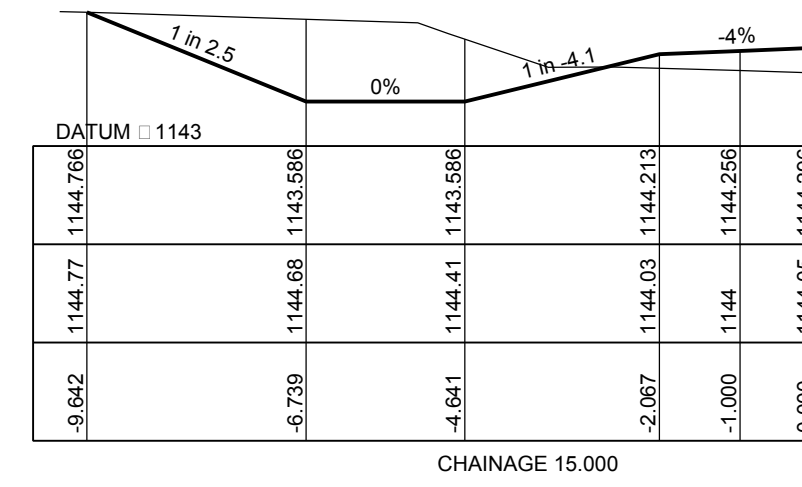
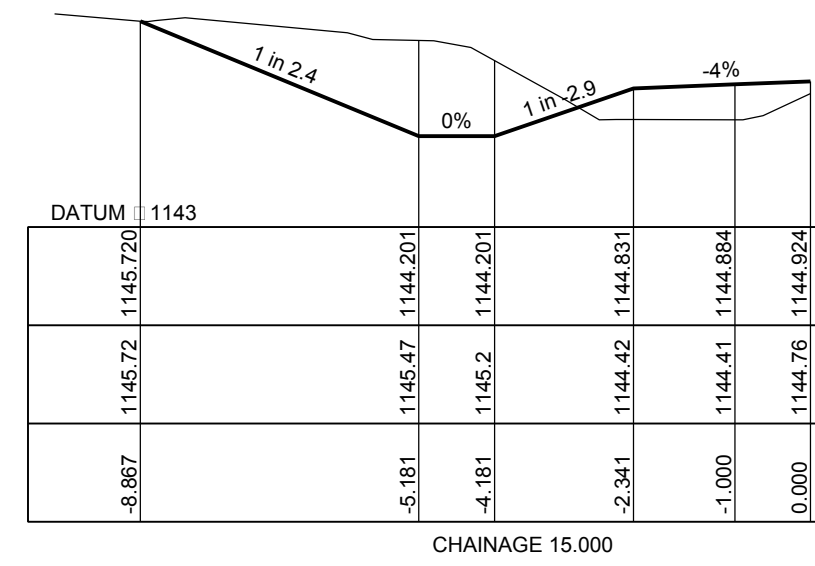

RETURN 1 CROSS-SECTIONS

RETURN 2 CROSS-SECTIONS

**LG ES LOCAL GOVERNMENT ENGINEERING SERVICES**  
 Pty Ltd ABN 64 055 099 557  
 Web: www.legs.com.au  
 Port Macquarie 69 Lord St, Port Macquarie NSW 2444  
 Ph: 02-65843888 Fax: 02-65843988  
 Email: john@legs.com.au  
 Inverell 17 Byron Street, Inverell NSW 2360  
 Ph: 02-67225110  
 Email: andrew@legs.com.au

CLIENT: GLEN INNES WIND POWER PTY LTD  
 PROJECT: PROPOSED WIND FARM ACCESS  
 GWYDIR HWY, 15KM WEST OF GLEN INNES  
 WINDFARM ACCESS ROAD CROSS SECTIONS  
 RETURN 1 & 2

SCALES: A1 ORIGINAL  
 0m 2 4 6 8 10  
 Section 1:100 (A1) 1:200 (A3)  
 FILE NAME: IV2545 GIWP WAD TSR Entry V2.dwg

DRAWN	DATE	JOB No.:	ISSUE	SHEET No.
MM	06/10/16	IV2545	C	8
DESIGNED	DATE	DOCUMENT No.:	OF 12	
ASD	06/10/16	WAD08		
APPROVED	DATE	STATUS:	APPROVAL	
ASD	06/10/16	REG. No.:	-	
DATUM:	-			

ISSUE	REVISION	AUTH	DATE
C	AMENDMENTS AFTER RMS REVIEW	A. D	14/12/16
B	AMENDMENTS AFTER SAFETY AUDIT	A. D	16/11/16
A	DETAILED DESIGN PLAN ISSUED FOR APPROVAL	A. D	06/10/16
ISSUE	REVISION	AUTH	DATE



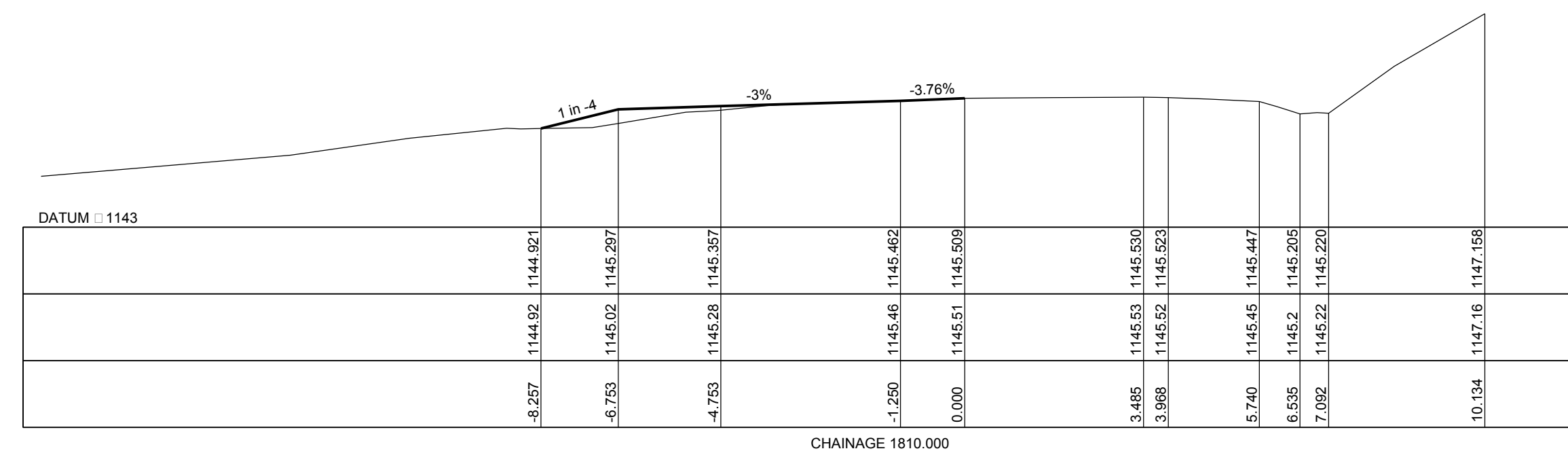
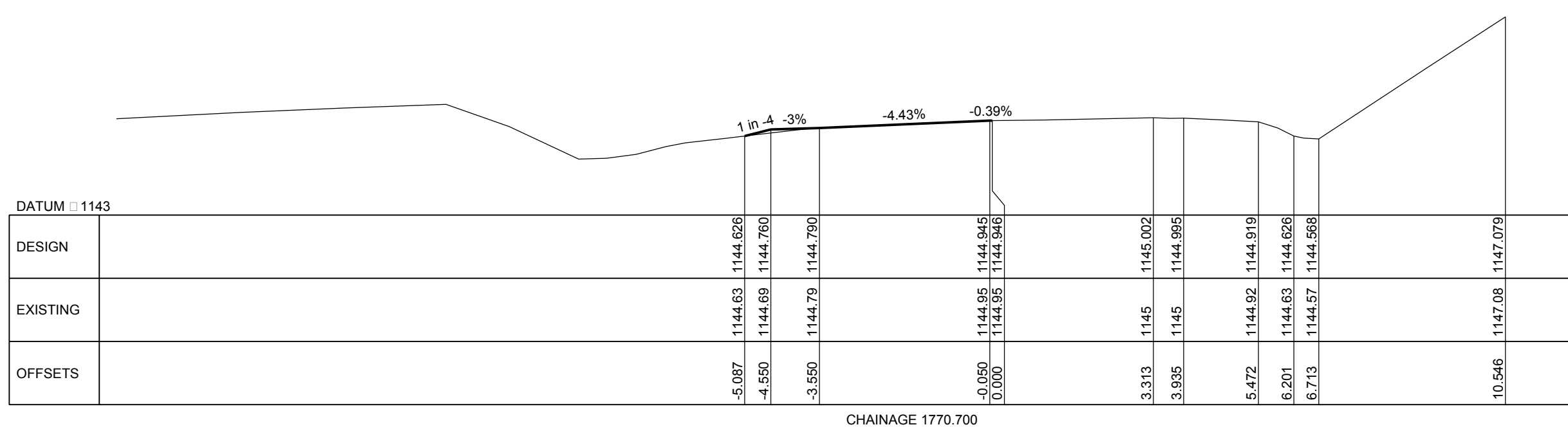
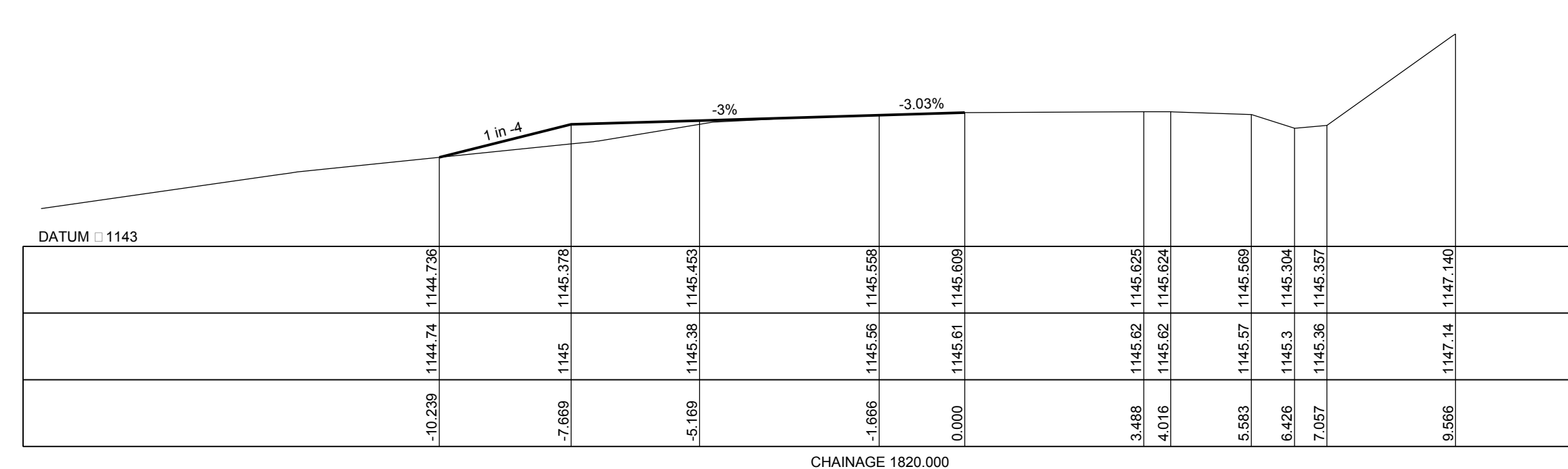
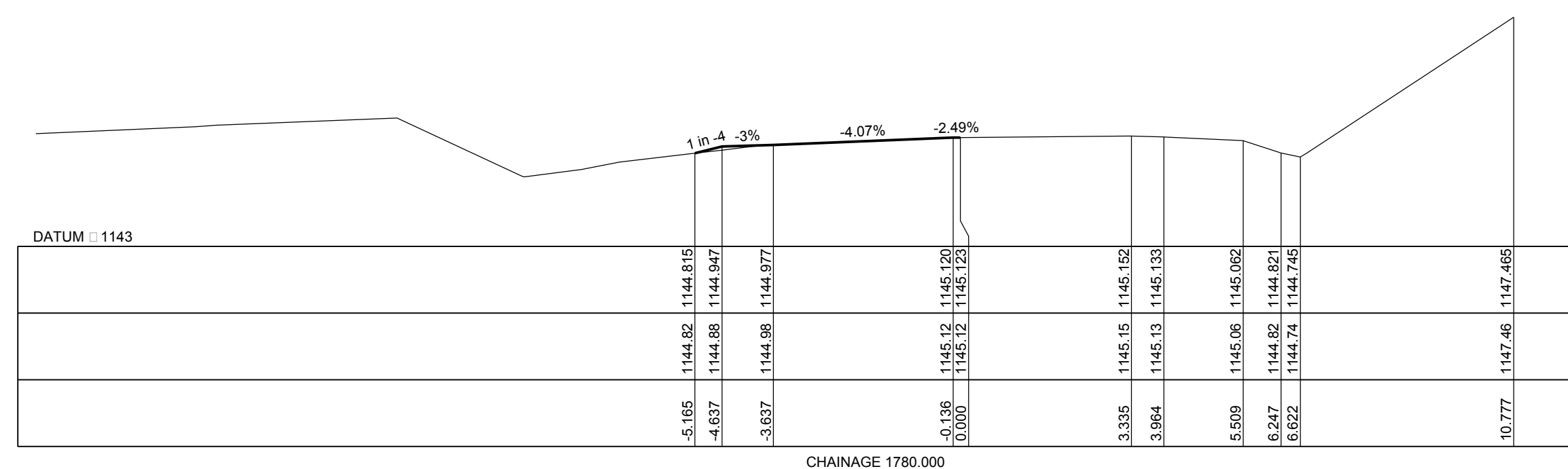
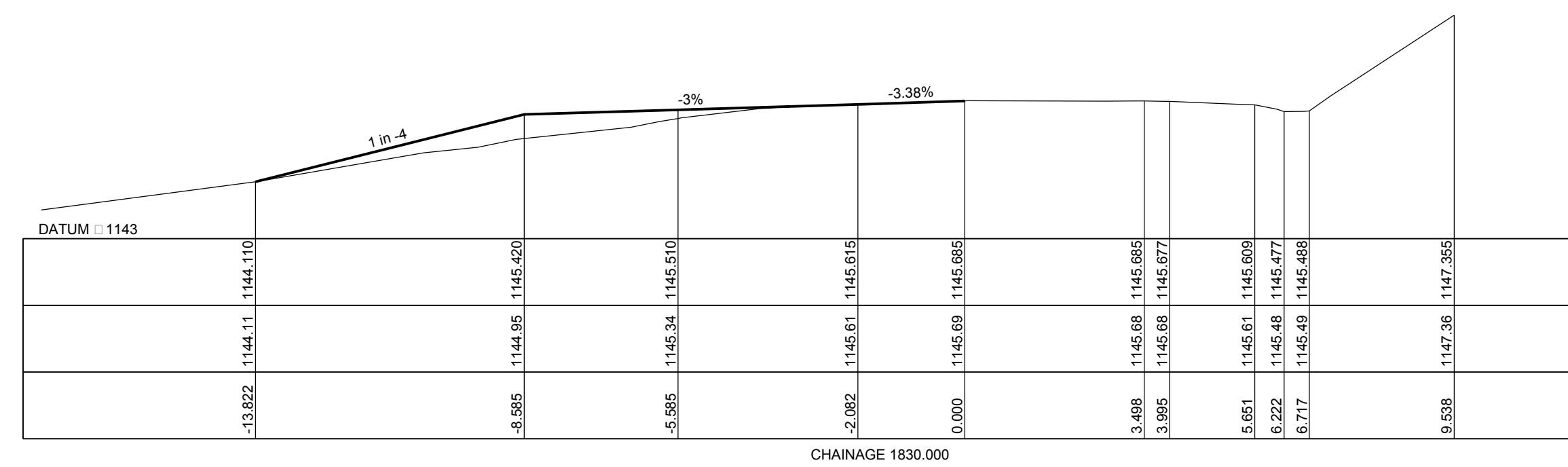
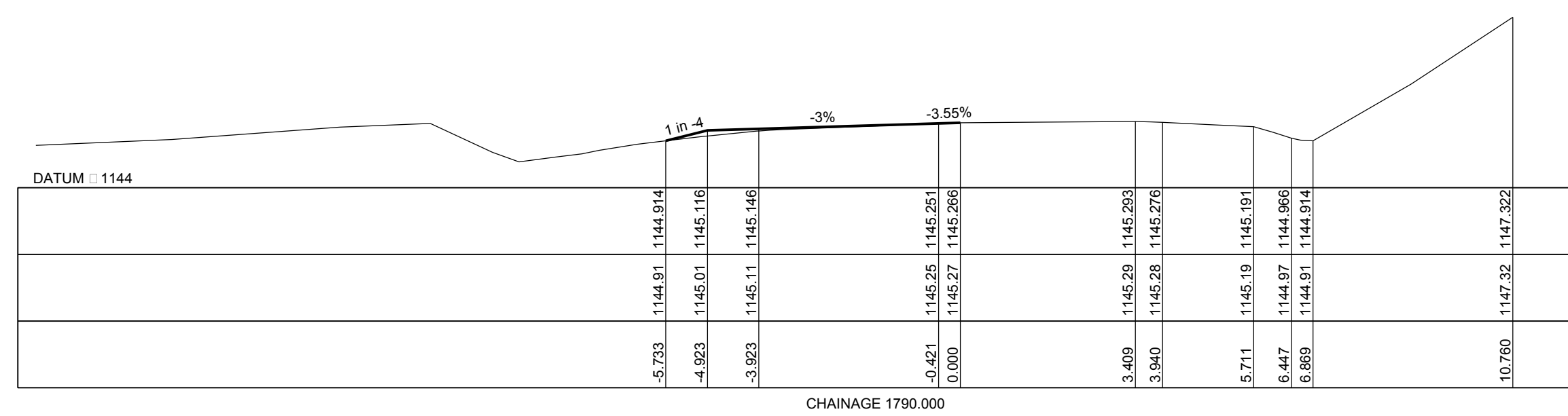
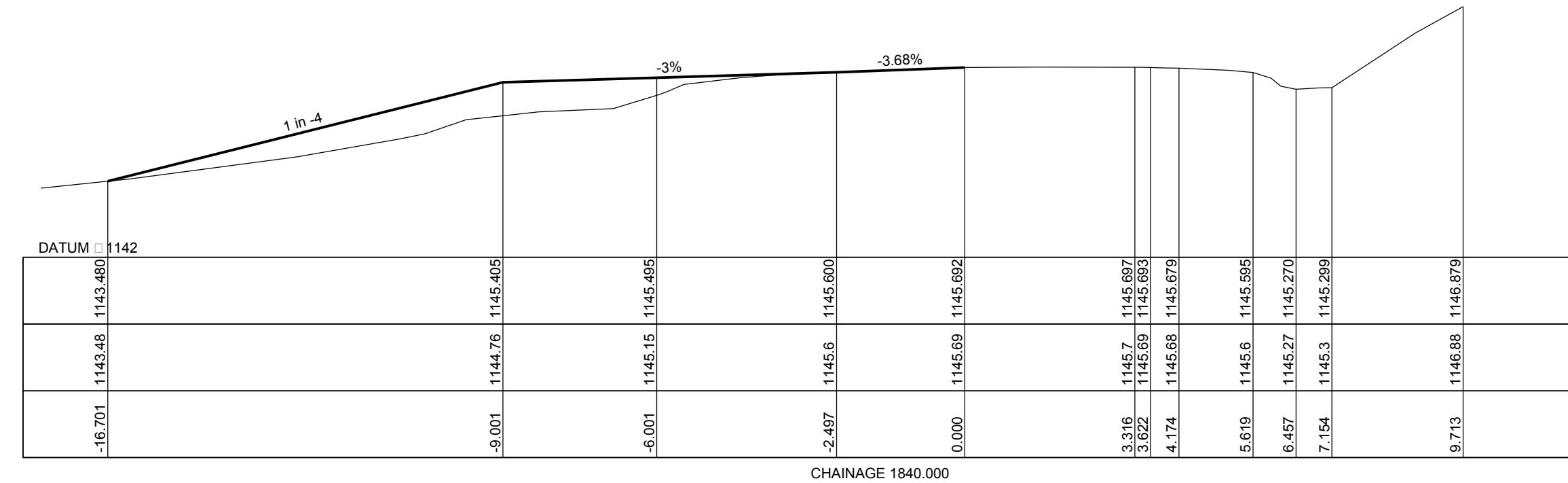
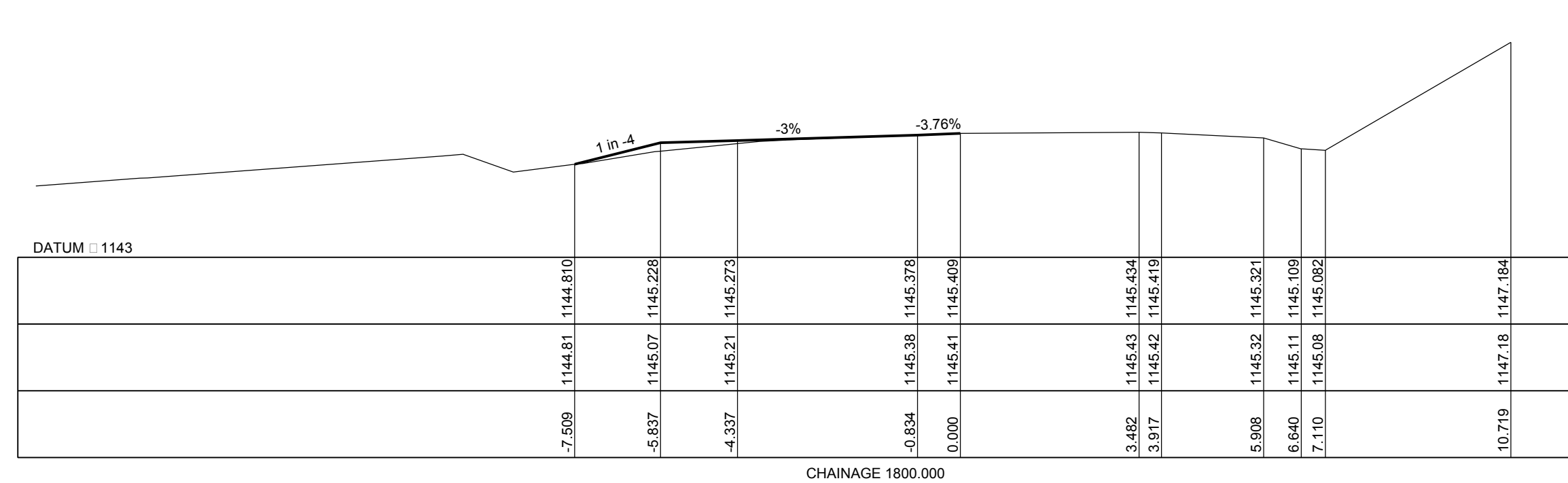

HIGHWAY CROSS-SECTIONS  
SHEET 1 OF 4

C	AMENDMENTS AFTER RMS REVIEW	A D	14/12/16
B	AMENDMENTS AFTER SAFETY AUDIT	A D	16/11/16
A	DETAILED DESIGN PLAN ISSUED FOR APPROVAL	A D	06/10/16
ISSUE	REVISION	AUTH	DATE

**LG ES LOCAL GOVERNMENT ENGINEERING SERVICES**

Pty Ltd ABN 64 055 099 557  
Web: www.legs.com.au

Port Macquarie Inverell  
69 Lord St, Port Macquarie NSW 2444 17 Byron Street, Inverell NSW 2360  
Ph: 02-65843888 Fax: 02-65843988 Ph: 02-67225110  
Email: john@legs.com.au Email: andrew@legs.com.au

CLIENT  
GLEN INNES WIND POWER PTY LTD

PROJECT  
PROPOSED WIND FARM ACCESS  
GWYDIR HWY, 15KM WEST OF GLEN INNES  
GWYDIR HWY WIDENING CROSS SECTIONS

SCALES  
A1 ORIGINAL

0m 2 4 6 8 10  
Section 1:100 (A1) 1:200 (A3)

FILE NAME: IV2545 GIWP WAD TSR Entry V2.dwg

DRAWN DATE  
MM 06/10/16

DESIGNED DATE  
ASD 06/10/16

APPROVED DATE  
ASD 06/10/16

DATUM: -

JOB No.: IV2545  
DOCUMENT No.: WAD09  
STATUS: APPROVAL  
REG. No.: -

ISSUE SHEET No.  
C 9  
OF 12

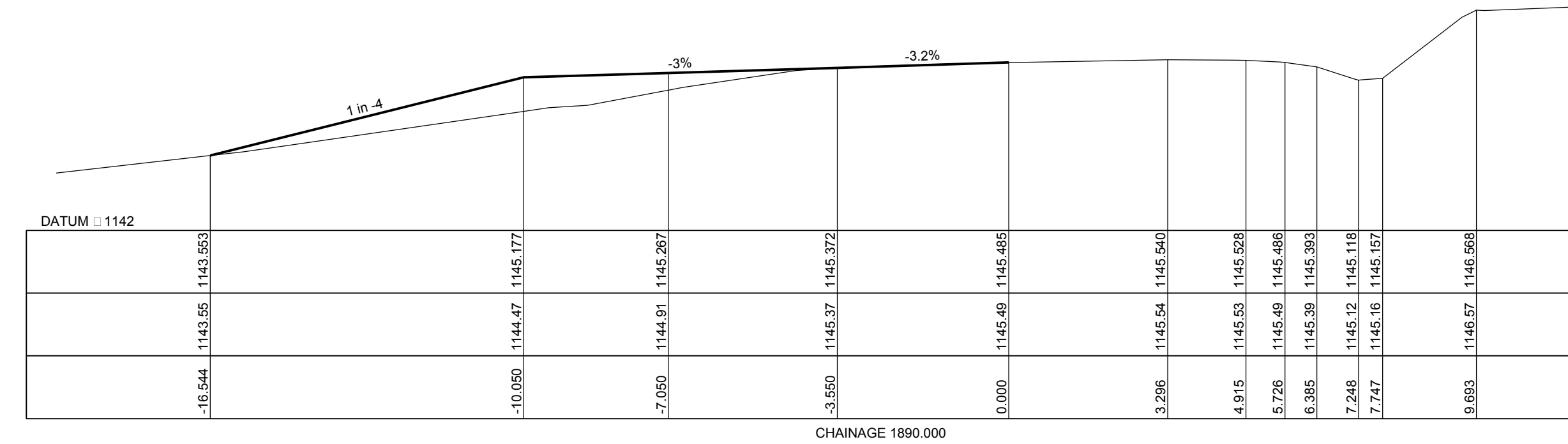
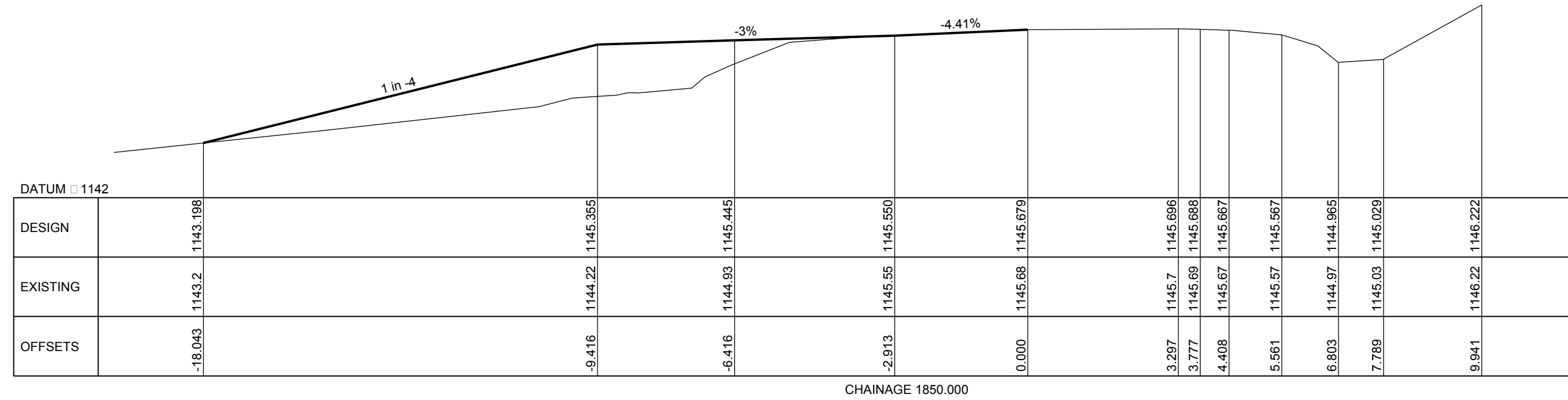
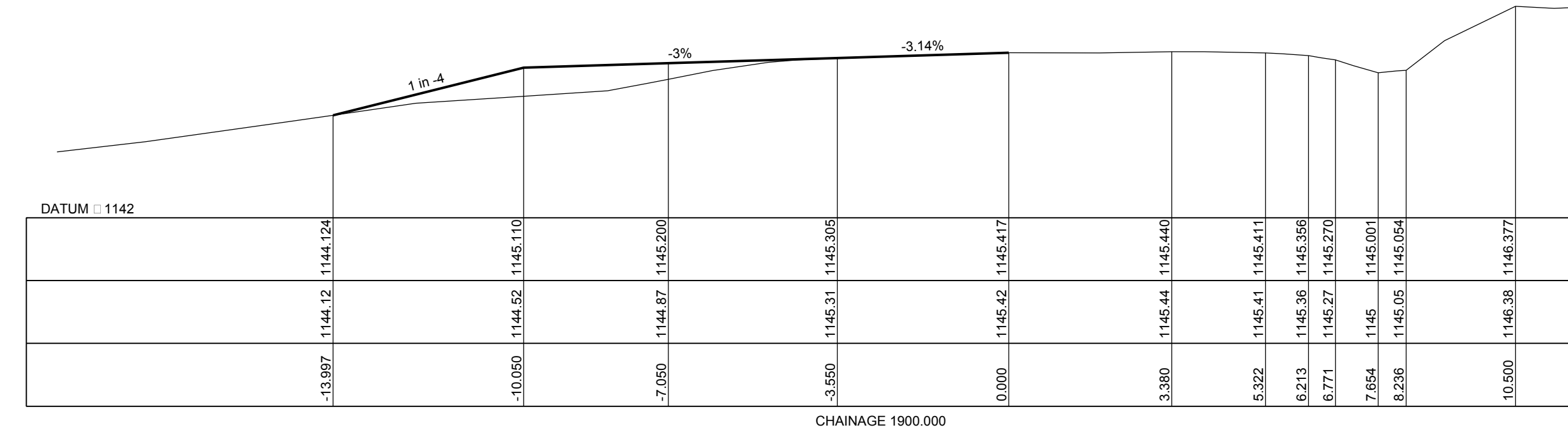
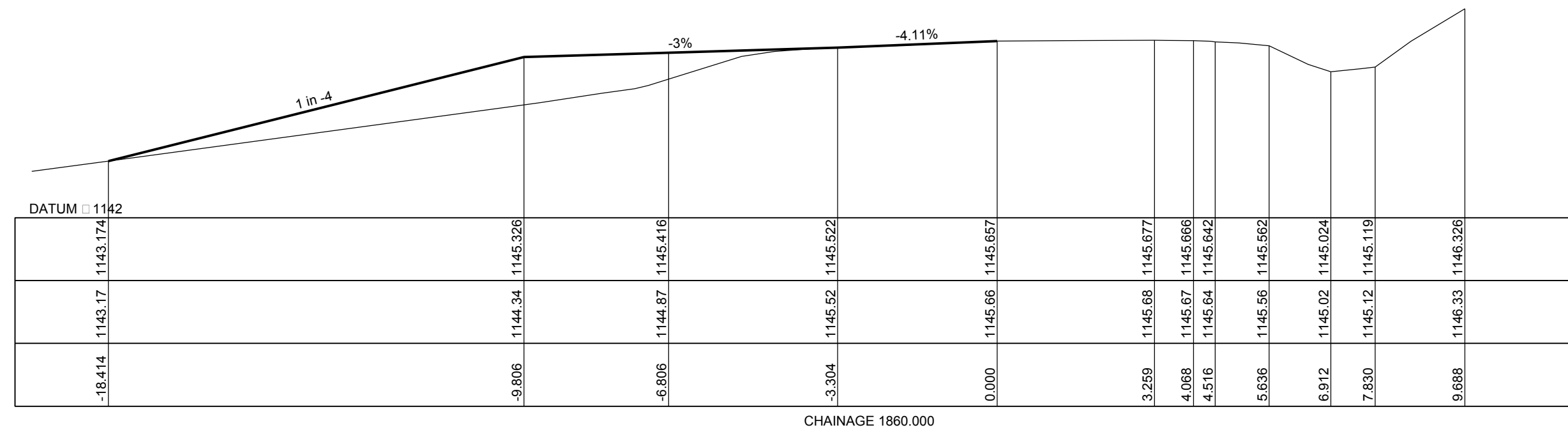
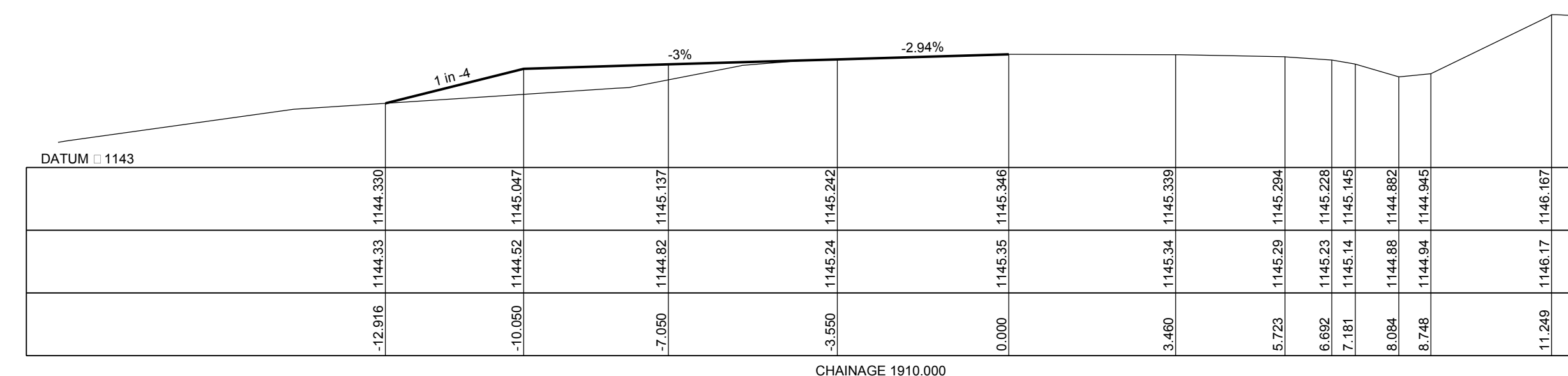
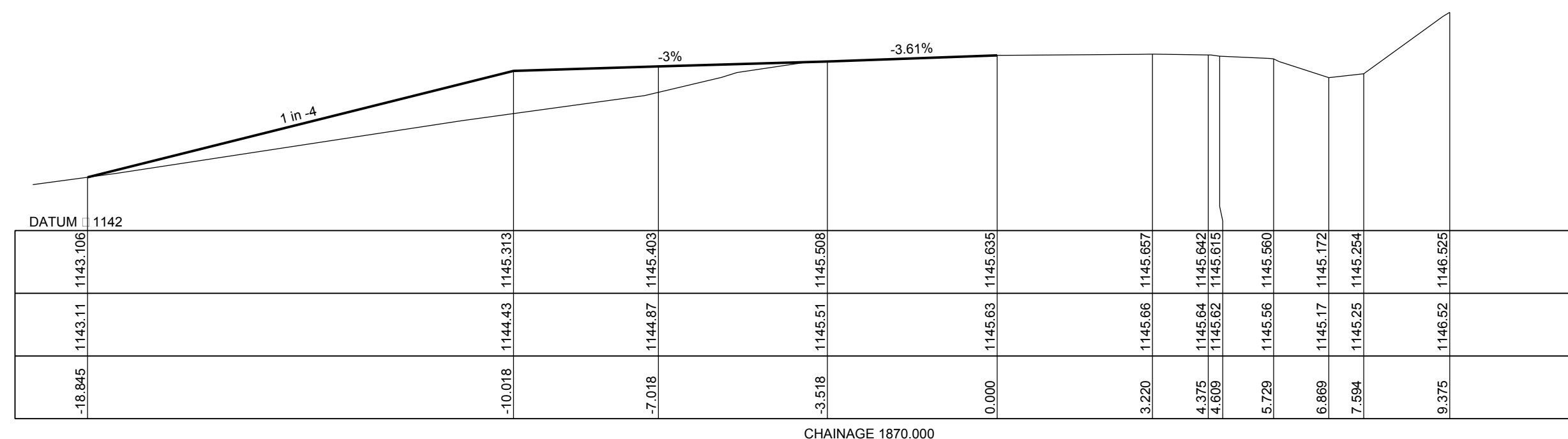
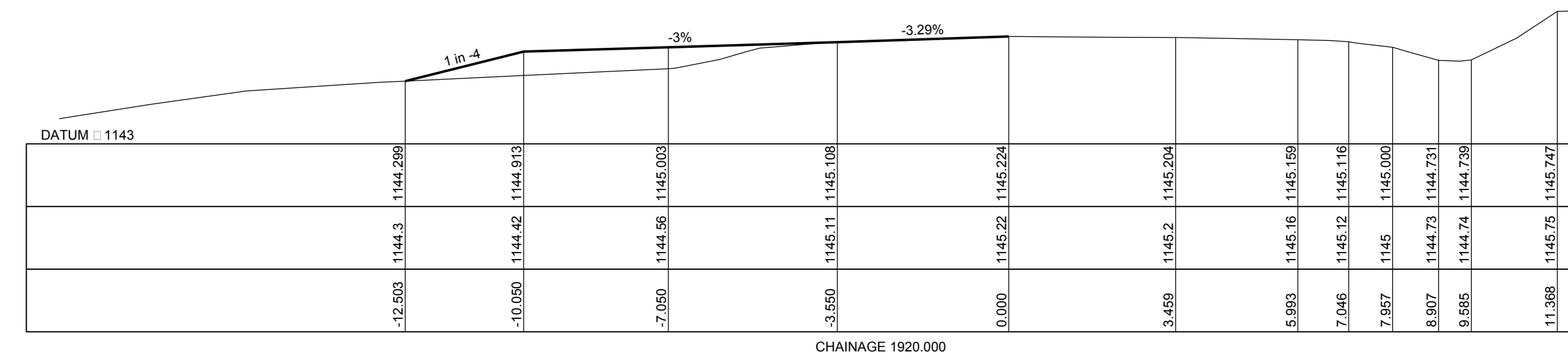
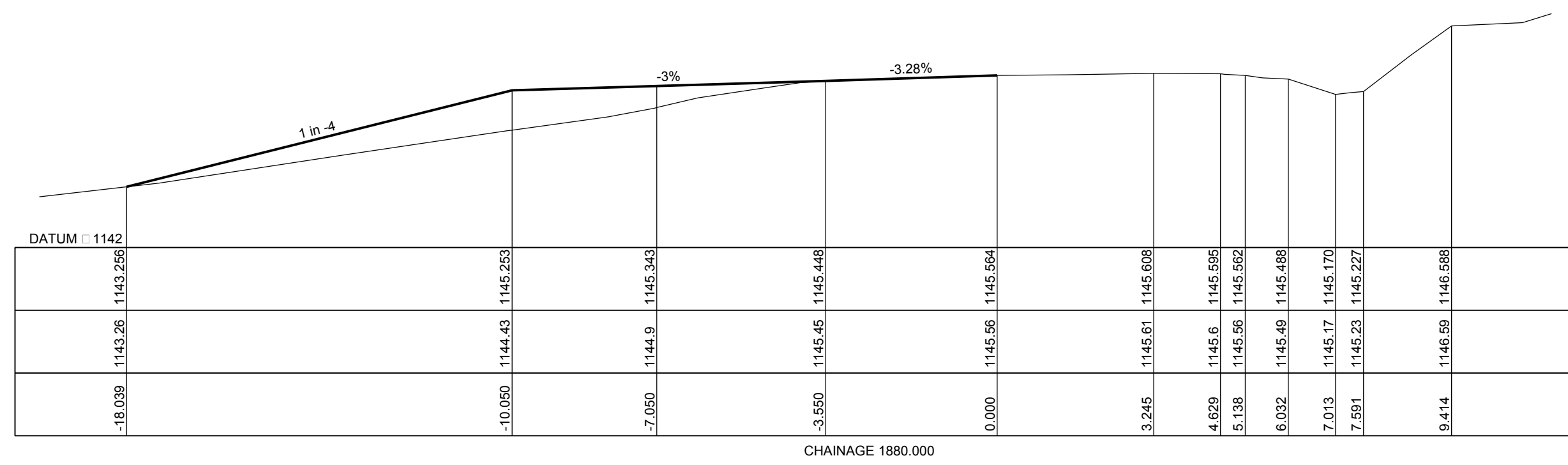

## HIGHWAY CROSS-SECTIONS SHEET 2 OF 4

ISSUE	REVISION	AUTH	DATE
C	AMENDMENTS AFTER RMS REVIEW	A D	14/12/16
B	AMENDMENTS AFTER SAFETY AUDIT	A D	16/11/16
A	DETAILED DESIGN PLAN ISSUED FOR APPROVAL	A D	06/10/16

**LG ES LOCAL GOVERNMENT ENGINEERING SERVICES**

Pty Ltd ABN 64 055 099 557  
Web: www.legs.com.au

**Port Macquarie** **Inverell**

69 Lord St, Port Macquarie NSW 2444  
Ph: 02-65843888 Fax: 02-65843988  
Email: john@legs.com.au

17 Byron Street, Inverell NSW 2360  
Ph: 02-67225110  
Email: andrew@legs.com.au

CLIENT  
GLEN INNES WIND POWER PTY LTD

PROJECT  
PROPOSED WIND FARM ACCESS  
GWYDIR HWY, 15KM WEST OF GLEN INNES  
GWYDIR HWY WIDENING CROSS SECTIONS

SCALES A1 ORIGINAL

0m 2 4 6 8 10  
Section 1:100 (A1) 1:200 (A3)

DRAWN DATE  
MM 06/10/16

DESIGNED DATE  
ASD 06/10/16

APPROVED DATE  
ASD 06/10/16

DATUM: -

FILE NAME: IV2545 GIWP WAD TSR Entry V2.dwg

JOB No.: IV2545	ISSUE C	SHEET No. 10
DOCUMENT No.: WAD10		OF 12
STATUS: APPROVAL		
REG. No.: -		

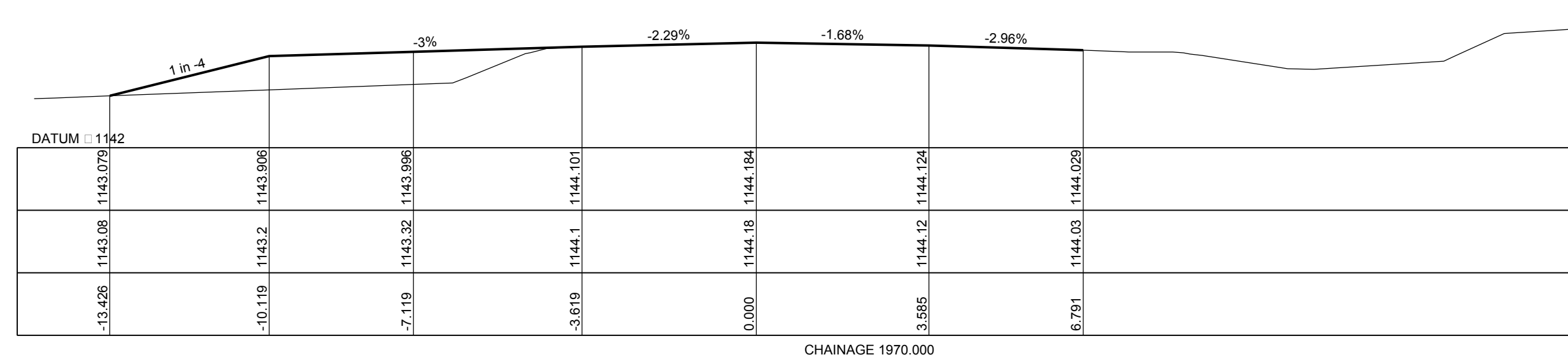
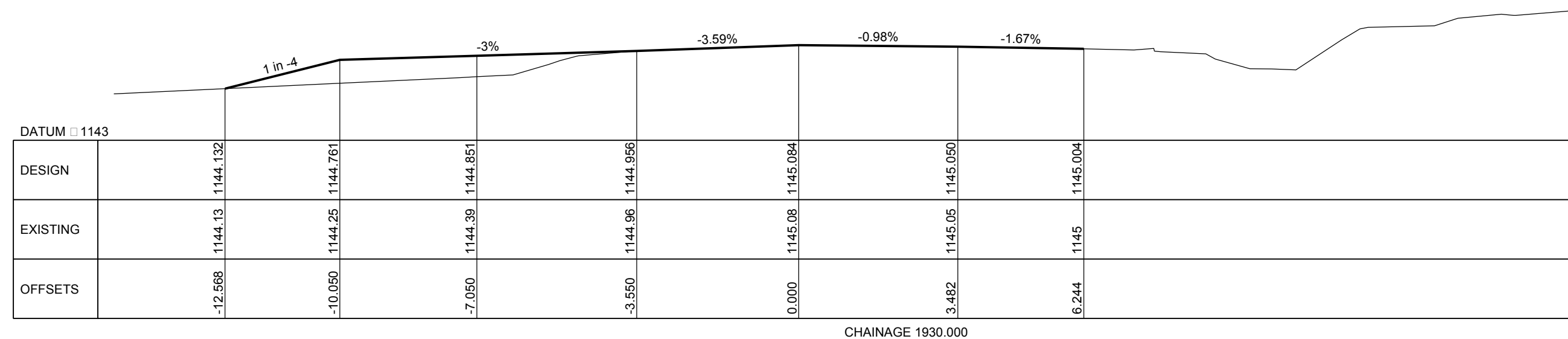
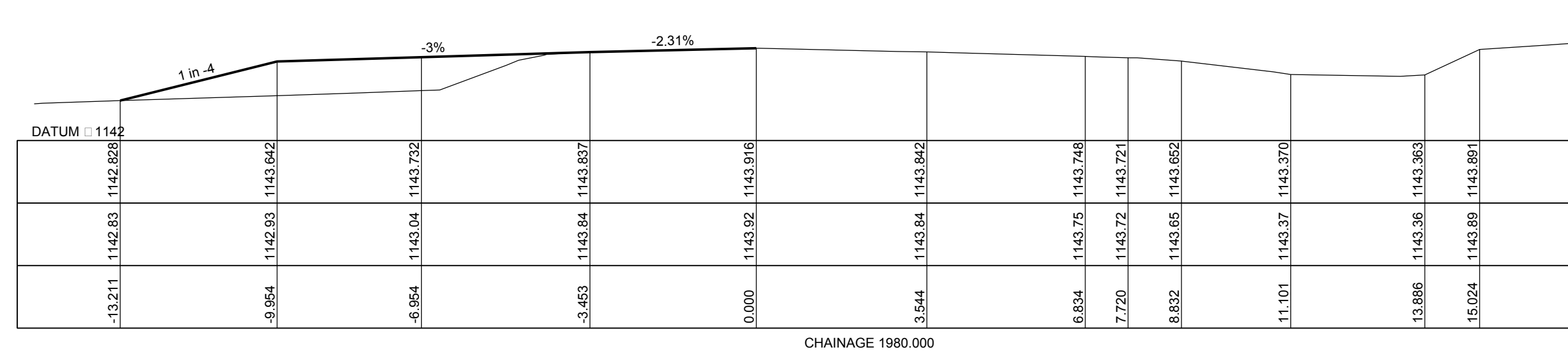
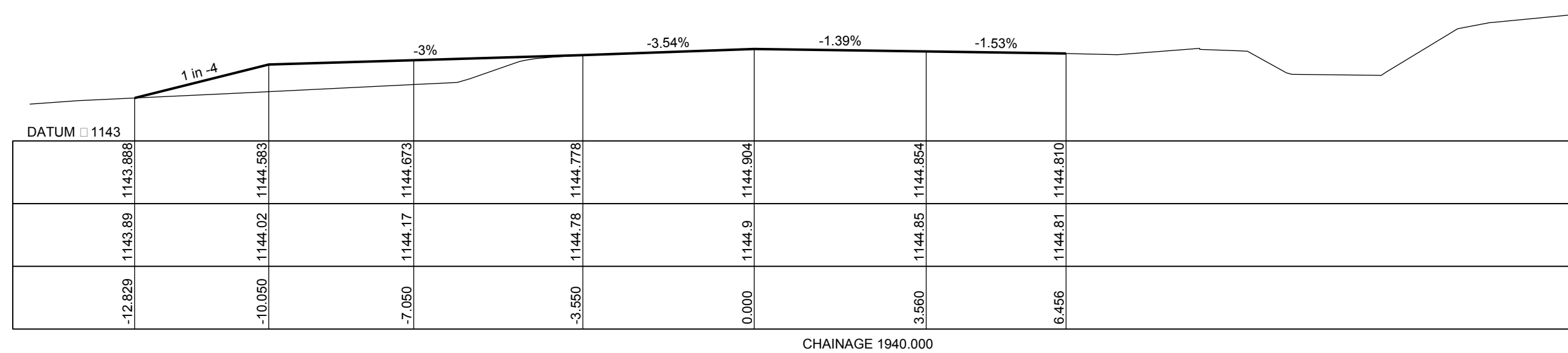
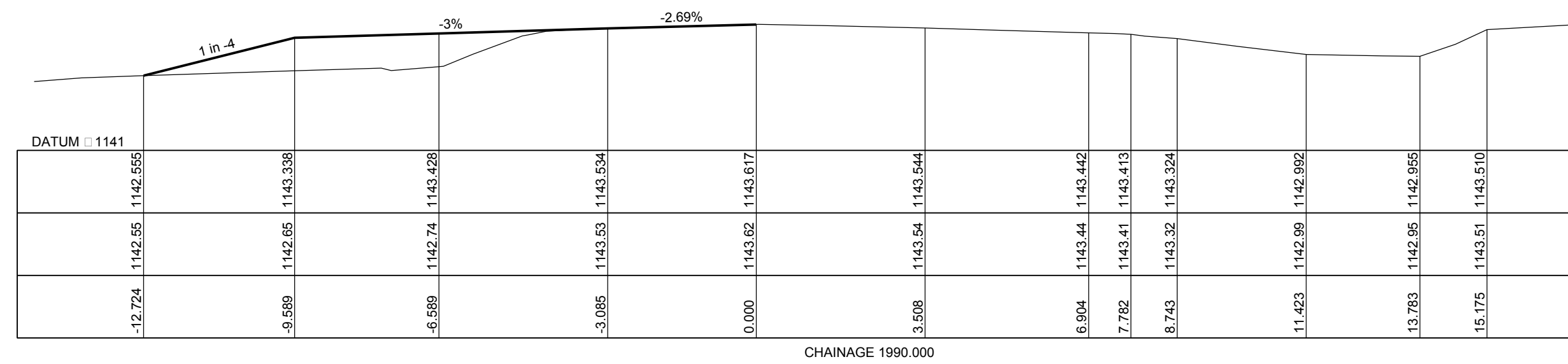
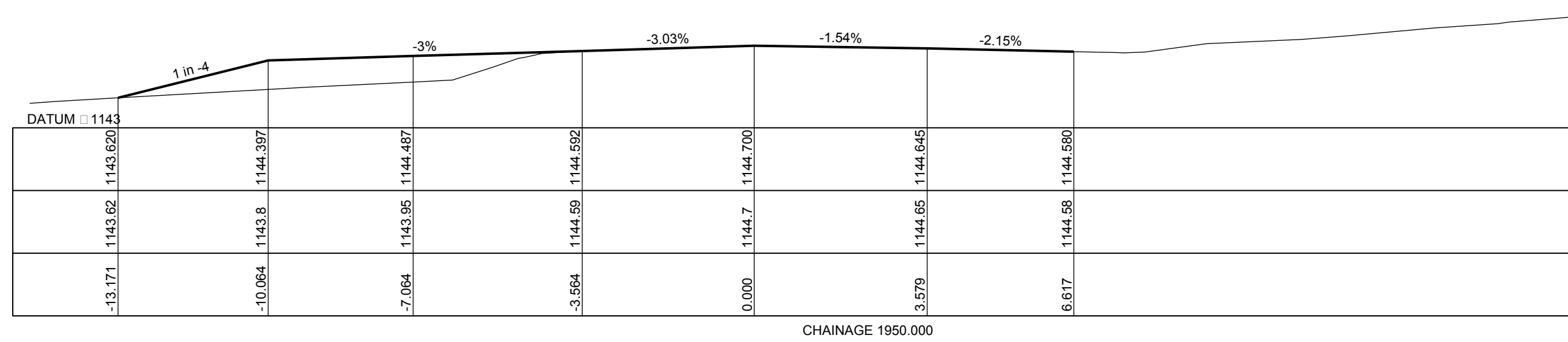
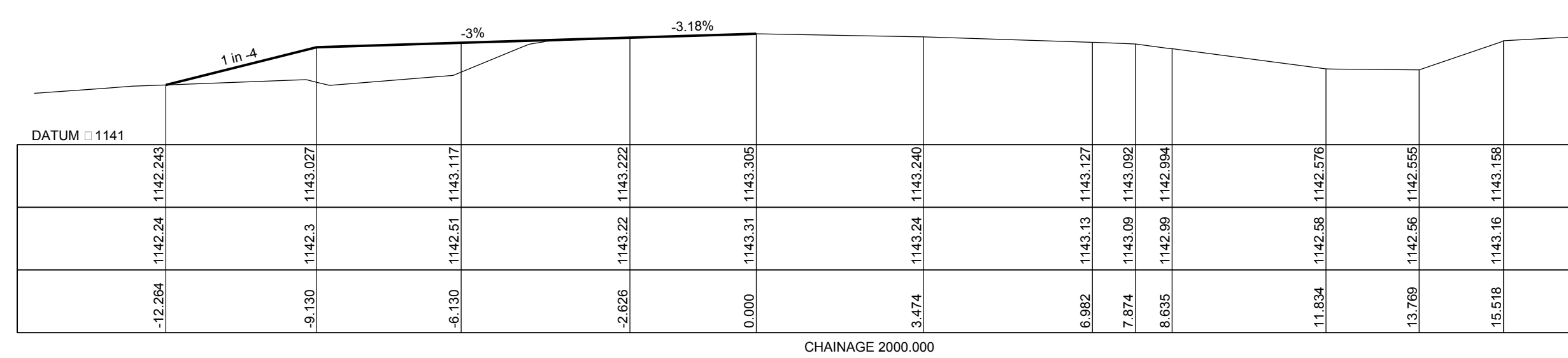
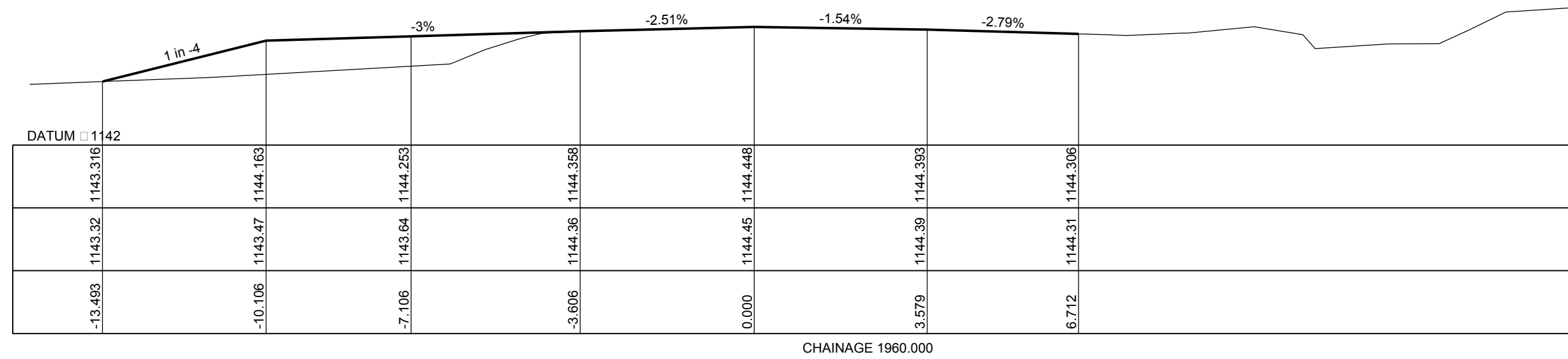

HIGHWAY CROSS-SECTIONS  
SHEET 3 OF 4

ISSUE	REVISION	AUTH	DATE
C	AMENDMENTS AFTER RMS REVIEW	A. D	14/12/16
B	AMENDMENTS AFTER SAFETY AUDIT	A. D	16/11/16
A	DETAILED DESIGN PLAN ISSUED FOR APPROVAL	A. D	06/10/16

**LG ES LOCAL GOVERNMENT ENGINEERING SERVICES**  
 Pty Ltd ABN 64 055 099 557  
 Port Macquarie 69 Lord St, Port Macquarie NSW 2444  
 Inverell 17 Byron Street, Inverell NSW 2360  
 Ph: 02-65843888 Fax: 02-65843988  
 Email: john@legs.com.au Email: andrew@legs.com.au

CLIENT: GLEN INNES WIND POWER PTY LTD  
 PROJECT: PROPOSED WIND FARM ACCESS  
 GWYDIR HWY, 15KM WEST OF GLEN INNES  
 GWYDIR HWY WIDENING CROSS SECTIONS

SCALES: A1 ORIGINAL  
  
 DATUM: -

DRAWN	DATE	JOB No.:	ISSUE	SHEET No.
MM	06/10/16	IV2545	C	11
DESIGNED	DATE	DOCUMENT No.:	OF	12
ASD	06/10/16	WAD11		
APPROVED	DATE	STATUS:	APPROVAL	
ASD	06/10/16	REG. No.:	-	

FILE NAME: IV2545 GIWP WAD TSR Entry V2.dwg

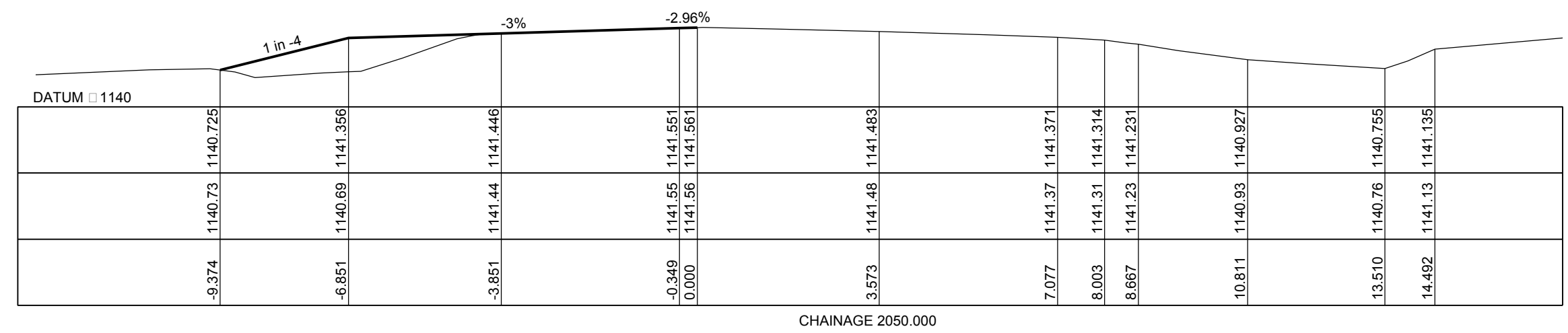
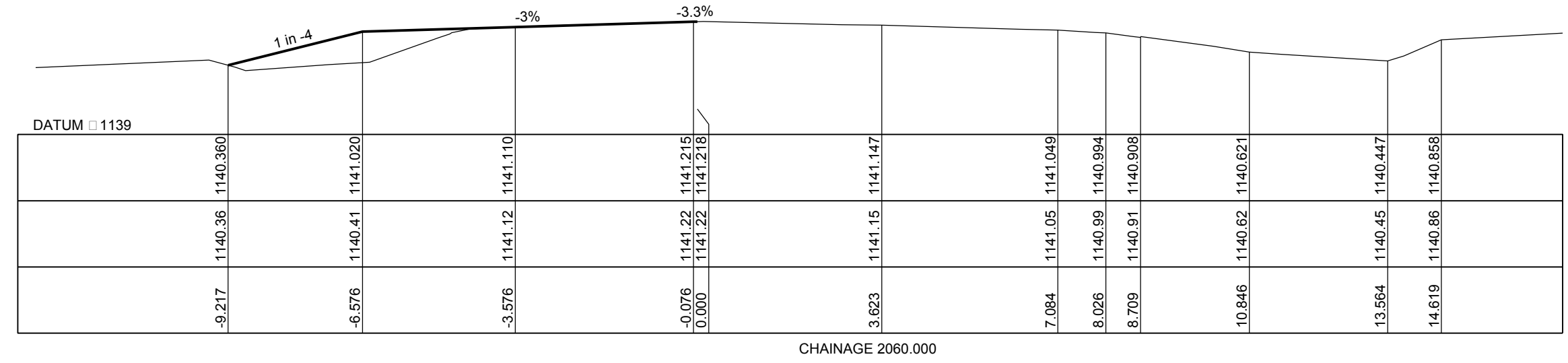
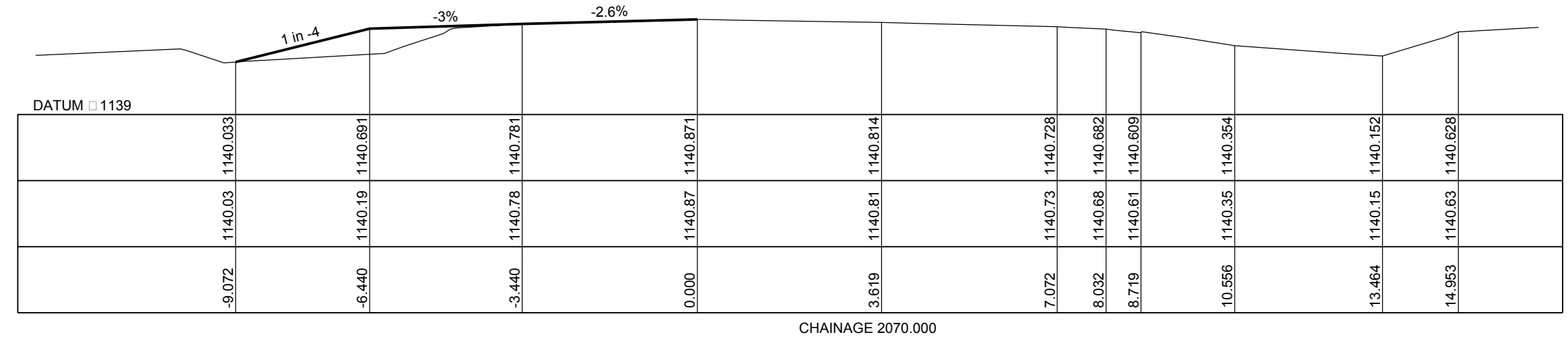
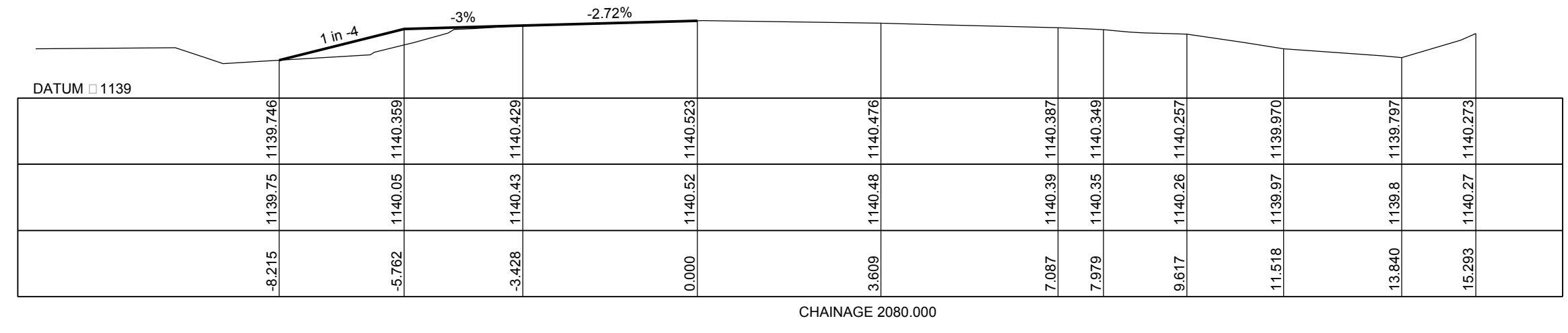
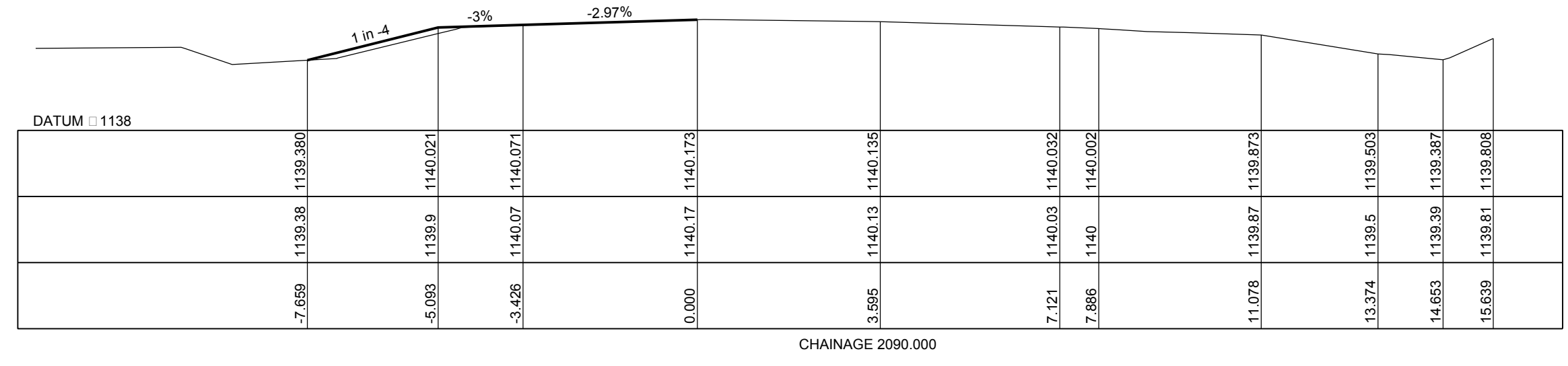
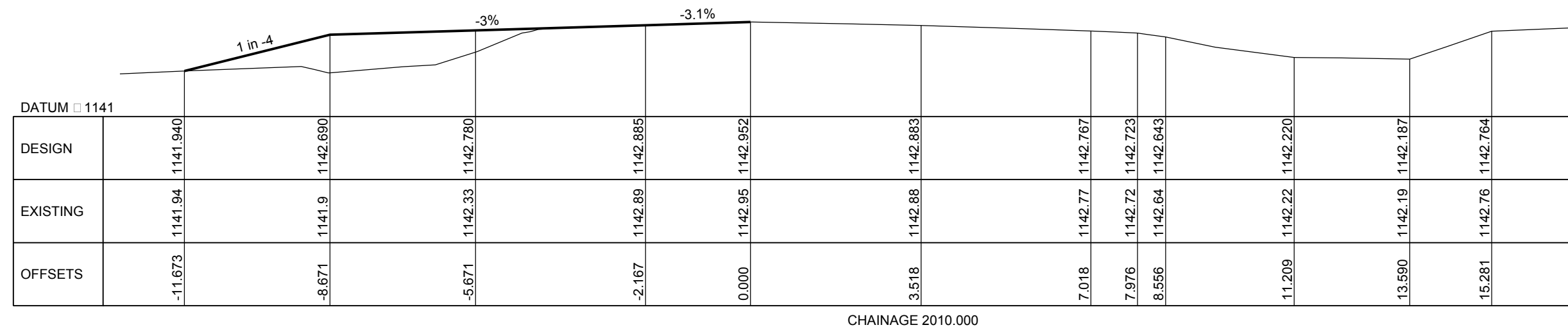
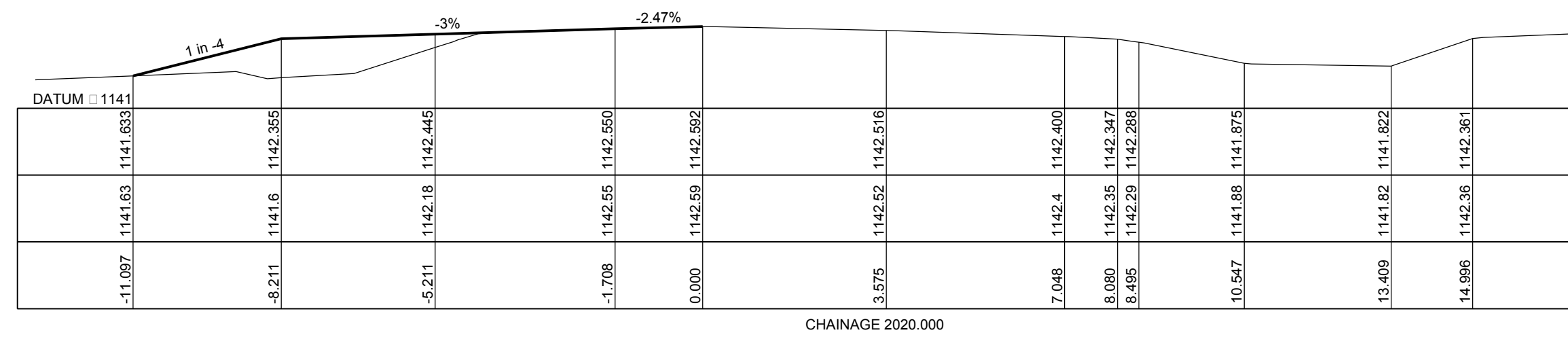
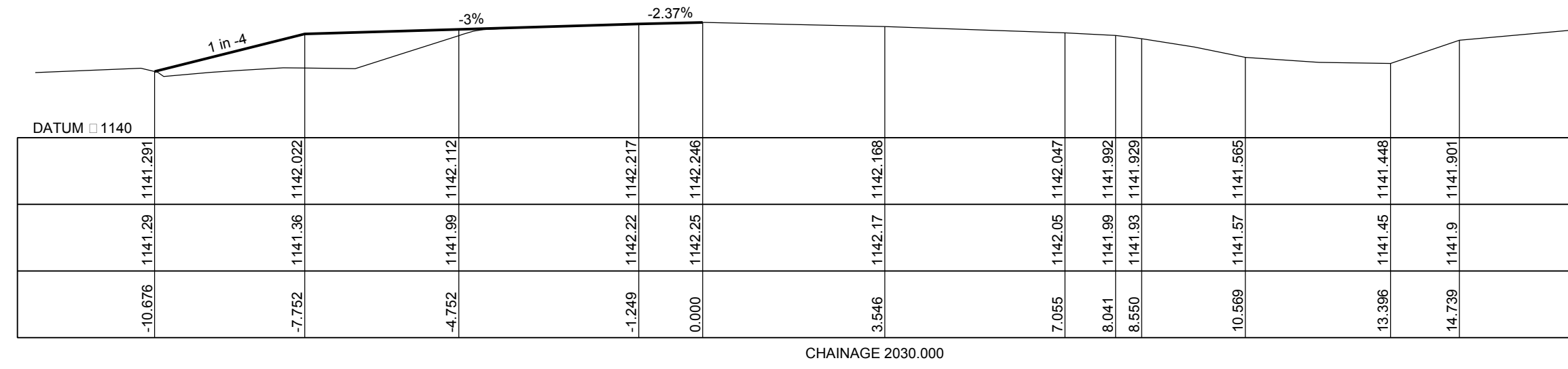
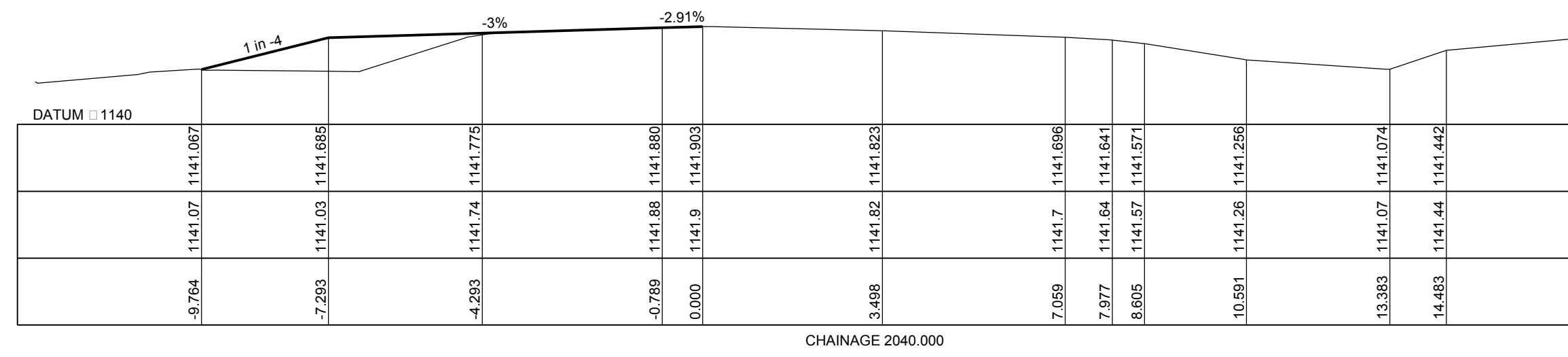

HIGHWAY CROSS-SECTIONS  
SHEET 4 OF 4

ISSUE	REVISION	AUTH	DATE
C	AMENDMENTS AFTER RMS REVIEW	A. D	14/12/16
B	AMENDMENTS AFTER SAFETY AUDIT	A. D	16/11/16
A	DETAILED DESIGN PLAN ISSUED FOR APPROVAL	A. D	06/10/16

**LG ES LOCAL GOVERNMENT ENGINEERING SERVICES**  
 Pty Ltd. ABN 64 055 099 557  
 Web: www.legs.com.au  
 Port Macquarie 17 Byron Street, Inverell NSW 2360  
 Ph: 02-65843888 Fax: 02-65843988  
 Email: john@legs.com.au Email: andrew@legs.com.au

CLIENT  
GLEN INNES WIND POWER PTY LTD  
 PROJECT  
PROPOSED WIND FARM ACCESS  
GWYDIR HWY, 15KM WEST OF GLEN INNES  
GWYDIR HWY WIDENING CROSS SECTIONS

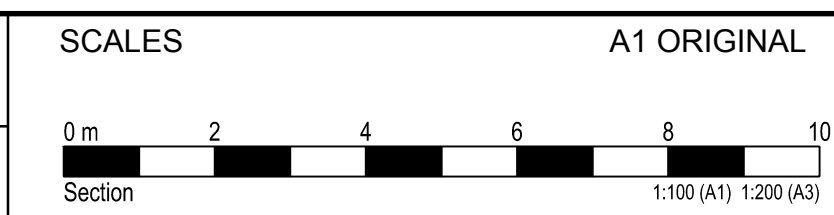

DRAWN DATE  
MM 06/10/16  
 DESIGNED DATE  
ASD 06/10/16  
 APPROVED DATE  
ASD 06/10/16  
 DATUM: -

JOB No.: IV2545  
 DOCUMENT No.: WAD12  
 STATUS: APPROVAL  
 REG. No.: -  
 ISSUE SHEET No. C 12 OF 12

FILE NAME: IV2545 GIWP WAD TSR Entry V2.dwg

## APPENDIX B

### PROPOSED EXIT-ONLY ACCESS DETAILED DESIGN



Our Ref: IV2545B

Wednesday, 21<sup>st</sup> December 2016

Director Infrastructure Planning  
Glen Innes Severn Council  
PO Box 61  
Glen Innes NSW 2370

Attn: Keith Appleby

**Re: Proposed Quarry Exit to Gwydir Highway, 15km West of Glen Innes**

Dear Keith,

I present to you the design drawings for the above proposal, and outline below the process taken and the engineering justification for the design. This cover letter may be used in support of the proposed works in your submissions to RMS.

## **Background**

It was initially intended to combine the entry and exit to this quarry development with the main access to the Glen Innes Wind Power windfarm development, at this location. However, through the design and approval process, the site constraints at the location were incompatible with a safe design for an entry off the highway. Therefore, the windfarm access was relocated to another position 800m to the east, and quarry vehicles will use that intersection, and enter the quarry from the rear, via the old highway alignment.

In order to make quarry vehicle movements more efficient, it was still preferable to provide an exit only intersection allowing quarry trucks to exit the site directly onto the highway, making either left or right turns.

## **Geometry**

Since the intersection is a one way only exit, there is no requirement to accommodate traffic slowing and entering off the highway from either direction. The exiting design vehicles and swept paths include the 19m Semi Trailer and Truck & Dog.

Therefore the intersection layout is based on a standard BAL treatment for the left turn exit, comprising a 16m radius and a 15m long widening taper in accordance with BAL geometry, and a simple 17m curved return radius on the eastern side, which accommodates exiting turn paths.

As there is no change to the east bound traffic, and no entering traffic, there is no need for a widened shoulder on the northern side.

## **Formation**

Being a one way only exit, the new roadway has a 3.5m wide single lane, 0.5m sealed shoulders (total minimum 4.5m seal) with 0.5m wide unsealed shoulders. Batters fall at a maximum 1:4 batter to the 1m wide table drains, and 1:4 batters to natural beyond.

The highway formation remains unchanged outside the tapers and returns. There is no work proposed to the northern shoulder (westbound).



## **Linemarking & Signage**

Linemarking is limited to edge lines around the returns, aligning with the existing edge lines, and a C1 continuity line across the throat. A TB Holding Line across the full width is used together with R1-2 Give Way signs on each side.

R2-6 L/R No Left/Right Turn signs are located at 48m from the intersection. This location is appropriate based on the need for slowing vehicles that may mistake the road for a legal entry, to correct and continue to proceed before reducing speed to an unsafe level. W5-22 symbolic Truck symbol signs are located at 120m from the intersection in each direction.

A pair of R2-4 No Entry signs are located beyond each end of the TB Hold Line, angled to favour the view from oncoming traffic in each direction.

A single EXIT ONLY sign is located near the property boundary facing exiting traffic.

A D4-2-3 Chevron located beyond the northern highway shoulder faces exiting traffic.

Existing signage will be maintained in existing positions. These include W5-20 / W8-7 Slippery When Wet signs on both sides of the highway and a moisture/temperature electronic Slow Down sign, all of which are facing westbound traffic. Ahead of the steep grade and small radius curve beyond.

## **Sight Distance**

Sight distance calculations have been performed using Austroads criteria (Guide to Road Design Part 4A), and are tabulated in the spreadsheet appended to this report.

The design speeds adopted for all vehicles except eastbound trucks is 110km/h.

The design speed adopted for east bound trucks is 100km/h.

The reduced eastbound truck speed is warranted because the location at which sight distance is first available to these vehicles is when they are just cresting the hill after having just ascended a steep climb (up to 8.5%). Trucks at that point are typically travelling at well below the 100km/hr speed limit, and although they do accelerate quickly, they do so at a point that is within the safe intersection sight distance (SISD) and so by then are in full view of the intersection and are able to elect to not accelerate if a potential hazard is apparent. Light vehicles however, can and do travel at high speeds over the crest, so the 110km/h design speed is appropriate.

110km/h is appropriate for all westbound vehicles, having a clear view and only a slight (1%) uphill grade on approach.

The location selected provides excellent sight distance to the east, for all heights of vehicles approaching along the highway and those waiting to exit onto the highway, well in excess of the maximums required by approaching trucks.

The sight distance to the west is effected by the crest located approximately 290m west of the intersection, but considering all required eye heights and vehicle visibility heights, the required SISD's are exceeded as shown on the sight distance profile on the drawing set.

## **Adverse visibility Conditions**

The locality is subject to periods of low visibility due to fog. Glen Innes Severn Council have advised that in such conditions, export of gravel at this location will be suspended, and the exit road will be closed to all exiting traffic movements. There is alternative access and exit via the new windfarm entrance intersection to the east for essential movements.

## **Drainage**

The location is located approximately midway between two major multi-cell pipe culverts passing under the highway, and as such, is located near the high point of the table drain, which essentially falls both east and west from the intersection point. This has enabled the intersection to be designed without a pipe culvert beneath.

The existing property access driveway is west of the crest point, and passes over a 450mm pipe culvert, which conveys table drain flows westward. This access pipe culvert will be removed, and the table drain re-

constructed such that the invert levels will be re-graded with a constant fall from the new entrance towards the natural gullies in either direction.

Pavement drainage is provided in the form of intra-pavement drains, in accordance with RMS design specifications, and these discharge into the table drains at each end.

### **Geotechnical**

A geotechnical investigation and RMS compliant pavement design has been carried out by Regional Geotechnical Solutions, and is documented in their report RGS 30969.1-AB Rev.1 14/12/16.

The pavement treatment and tie-in detail is provided in the report and on the drawing set. Although the new pavement works will not encroach onto the existing through traffic highway lanes, the RMS requirements have been accounted for, and in particular, the following points are relevant:

- The RMS requirements for a minimum acceptable pavement thickness of 450mm are adopted.
- Detailed investigations were carried out indicating CBR values of 6 and 13 on the southern shoulder.
- On this basis, and considering the stated preference by RMS for the new pavement to be a granular pavement with no modification or stabilisation, a pavement thickness of 520mm has been adopted.
- An interface drain has been added between the existing and new pavement, and located below the 520mm pavement thickness, and located under the joint in the sub base layer along the line of the original edge line, with outlets to batters at spacings in accordance with RMS STD Drawings.
- Tensar grid reinforcing will be laid over this joint below the base course.
- Wearing course will be a two coat seal overlapping the existing seal, with paving fabric used to reinforce the joint.
- Appendix C of the Geotechnical report provides references to RMS construction specifications. As per the recommended pavement material section, the base and sub-base shall be DGB20 as per RMS spec 3051, placed in accordance with RMS spec R71. The select material shall be as per RMS spec 3071 and placed in accordance with RMS spec R44

The revised Geotechnical Report is attached, along with the updated RMS Pavement Design Checklists and Pavement Design Approval forms. These should be submitted to RMS with the drawings and this cover letter for approval.

Yours Faithfully,



Andrew Dekkers

BE Civil, MIEAust  
Manager, Inverell  
Local Government Engineering Services

### **Attachments:**

Sight Distance Calculations

Geotechnical Investigation and Pavement Design Report - RGS 30969.1-AB Rev.1 14/12/16

ABN: 64 055 099 557      www.legs.com.au  
 17 Byron St                    69 Lord St  
 Inverell ,NSW, 2360        Port Macquarie , NSW, 2444  
 Ph : 02 67225110            Ph: 02 65843888  
    Fax: 02 65843988  
 email: andrewlegs.com.au    email: john@legs.com.au

## AUSTROADS INTERSECTION DESIGN

**Project:** Proposed Quarry Exit to Gwydir Hwy, 15km West of Glen Innes  
**Client:** Glen Innes Severn Council  
**Date:** 21/12/2016

### Description

New BAL Exit Only from new Quarry onto Gwydir Highway 15km west of Glen Innes

Normal Design Domain Values are adopted unless noted otherwise, in which case Extended Design Domain (EDD) values are considered - Austroads AGRD04A App A

### 2.2 Alignment of Approaches

#### 2.2.1 Horizontal Alignment

Rural Road approach geometry, refer: Austroads AGRD part 3

#### 2.2.2 Vertical Alignment

Approach Grade Criteria  
 desirable - upgrade desirable <3% (max 4%) min 10m from edge line (or design vehicle length)  
 desirable - downgrade desirable 3% (max 5%). For trucks: High friction and SDD

#### 2.2.3 Combined Hor & Vert Curves

#### 2.2.4 Superelevation at or near l'sects

### 3.0 Sight Distance

#### 3.2 Requirements

SSD - Stopping Sight Distance

ASD - Approach Sight Dist

SISD - Safe Intersection Sight Distance

MGSD - Minimum Gap Sight Distance

#### Measured

Cars (Major Road, 1.1m to 0.2m)

Trucks (Major Road, 2.4m to 0.2m)

Cars (Minor Road, 1.1m to 0.0m)

Trucks (Minor Road, 2.4m to 0.0m)

Cars (Major Road, 1.1m to 1.25m), 5m setback

Trucks (Major Road, 2.4m to 1.25m), 5m setback

#### SSD & SISD - Major/Through road

Reaction time - Rural locality

Observation time - Rural locality

Coefficient of Deceleration

#### Eastbound

Operating Speed (85th percentile)

Longitudinal Grade

SSD

SISD

	Cars	Trucks	Cars	Trucks	
R <sub>T</sub>	2.5	2.5	2.5	2.5	sec
DT	3	3	3	3	sec
d <sub>(car)</sub>	0.36	0.29	0.36	0.29	
V	110	100	110	110	km/h
a <sub>1</sub>	-4.5	-4.5	-1	-1	%
SSD	227.62	230.14	212.50	246.52	1.1c (2.4t) to 0.1
SISD	319.29	313.47	304.16	338.19	1.1c (2.4t) to 1.25c